

# OPERATIONS MANUAL

D602277-03 (doc # 602277) (Rev 5/16/14)



## AP4+

*AutoPump Controllerless System  
(For 4 inch wells or larger)*

**DURABLE,  
DEPENDABLE,  
& DELIVERS**

Copyright QED Environmental Systems, Dec. 2010

The equipment in this manual is protected under U.S. and foreign patents issued and pending:

**U.S. Patents:**

AutoPump (AP) 5,004,405

"AP" is a Registered Trademark of "QED Environmental Systems"

"AutoPump" is a Registered Trademark of "QED Environmental Systems"

The QED Environmental Systems logo is a Registered Trademark of "QED Environmental Systems"

QED Environmental Systems is a Registered Trademark of "QED Environmental Systems"

<b>Introduction</b>	<b>1</b>
Safety	1
How to Contact QED	1
<b>Chapter 1: Safety</b>	<b>2</b>
A Partial List of Safety Procedures	2
Fire and Explosion Protection	2
<b>Chapter 2: Overview</b>	<b>3</b>
General Specifications	3
This is How it Works	3
<b>Chapter 3: Equipment</b>	<b>6</b>
Unpacking	6
Equipment List	6
Single Stage Filter/Regulator	6
<b>Chapter 4: Installation</b>	<b>7</b>
Installation	7
Hose Bundling	8
<b>Chapter 5: Maintenance</b>	<b>11</b>
Cleaning Pump Interior	11
Iron Build-up Cleaning Procedure	11
<b>Chapter 6: Troubleshooting &amp; Repairs</b>	<b>18</b>
Troubleshooting	18
Returning Equipment for Service	20
Equipment Cleaning Requirements	20
<b>Pump Specifications</b>	<b>21</b>
AP4+ Bottom Inlet Long	21 - 24
AP4+ Bottom Inlet Short	25 - 28
AP4+ Bottom Inlet Low Drawdown	29 - 32
AP4+ Top Inlet Long	33 - 36
AP4+ Top Inlet Short	37 - 40
AP4+ Top Inlet Low Drawdown	41 - 44
<b>Terms, Conditions and Warranty</b>	<b>45</b>
<b>Figures:</b>	
<b>Figure 1</b> - How it Works	4
<b>Figure 2</b> - Overview of the AutoPump System	5
<b>Figure 3</b> - Single Stage Filter/Regulator 60 with Quick-Connects	6
<b>Figure 4</b> - Examples of Well Caps	9
<b>Figure 5</b> - Hose Bundling	10
<b>Figure 6</b> - Exploded View of a Bottom-Loading AutoPump AP-4+ (Long & Short)	12
<b>Figure 7</b> - Exploded View of a Bottom-Loading AutoPump AP-4+ (Low Drawdown)	13
<b>Figure 8</b> - Exploded View of a Top-Loading AutoPump AP-4+ (Long & Short)	14
<b>Figure 9</b> - Exploded View of a Top-Loading AutoPump AP-4+ (Low Drawdown)	15
<b>Figure 10</b> Exploded View of AP-4+ Lever Assembly	16
<b>Figure 11</b> Exploded View of 1-Inch Brass Check Valve	17

Welcome to QED Environmental Systems' AutoPump® (AP4+) manual.

To ensure the best operator safety and system performance, it is strongly recommended that the operators read this entire manual before using the system.

This manual reflects our many years of experience and includes comments and suggestions from our sales and service personnel and most importantly from our customers. The chapters, their contents and sequence were designed with you, the user and installer, in mind. We wrote this manual so it can be easily understood by users who may not be familiar with systems of this type or are using a QED system for the first time.

## Safety

Safety has been a cornerstone of our design which has been proven out in building and shipping systems throughout the world. Our high level of performance is achieved by using quality components, building in redundancies or backup systems, and not compromising our commitment to quality manufacturing. The net result is the highest quality and safest pneumatic pump recovery system on the market. We feel so strongly about safety, based on years of working with the hydrocarbon industry, that it is the first section of all our manuals

## How to Contact QED

If for any reason you are unable to find what you need in this manual feel free to contact the QED Service Department at any time. We encourage you to use following communication methods to reach us at any time:

**Service Department**  
QED Environmental Systems  
[www.qedenv.com](http://www.qedenv.com)

**San Leandro Service Center**  
1670 Alvarado Street  
San Leandro, California 94577-2640

**Ann Arbor Service Center**  
2355 Bishop Circle West  
Dexter, Michigan 48130

(800) 537-1767 — North America Only  
(510) 346-0400 — Tele.  
(510) 346-0414 — Fax

(800) 624-2026 — North America Only  
(734) 995-2547 — Tele.  
(734) 995-1170 — Fax  
[info@qedenv.com](mailto:info@qedenv.com) — E-mail

QED can be reached 24 hours a day

We welcome your comments and encourage your feedback regarding anything in this manual and the equipment you have on-site.

Thank you again for specifying QED equipment.



Safety has been a prime consideration when designing the AutoPump System. Safety guidelines are provided in this manual, and the AutoPump System safety features are listed below. Please do not attempt to circumvent the safety features of this system.

We have also listed some possible hazards involved when applying this system to site remediation. Nothing will protect you as much as understanding the system, the site at which it is being used, and the careful handling of all equipment and fluids. If you have any questions, please contact the QED Service Department for guidance.

As you read through this manual, you will encounter three kinds of warnings. The following examples indicate how they appear and lists their respective purposes.

**Note:** Highlights information of interest.

**Caution:** Highlights ways to avoid damaging equipment.

**Warning:** Highlights personal safety issues.

## A Partial List of Safety Procedures

**WARNING:** The air compressor and any other electrical equipment used with this pneumatic system must be positioned outside of any area considered hazardous because of possible combustible materials.

These safety procedures should be followed at all times when operating QED equipment on or off site, and should be considered as warnings:

- Wear safety goggles when working with the AutoPump System to protect eyes from any splashing or pressure release.
- Wear chemically resistant rubber gloves, boots, and coveralls when handling the AutoPump and fluid discharge hose to avoid skin contact with the fluid being removed
- Point tubing/hoses away from personnel and equipment when connecting or disconnecting.
- Always ensure that the fluid discharge line is connected before the air line to prevent accidental discharge.

The AutoPump System minimizes the potential for accidents with the following safeguards:

## Fire and Explosion Protection

Almost all of QED underground fluid extraction systems are pneumatic. This offers many inherent fire and explosion protection features.

The AutoPump® fills and empties automatically, and is very easy to install, use, and maintain.

The AutoPump is a pneumatic fluid extraction pump that pumps in pulses. It handles any liquid which flows freely into the pump and is compatible with the component materials and with the connecting hoses. The AP4+ is intended for vertical operation in well casings with a 3.75-inch or greater internal diameter. It can pump particles up to 1/8-inch in diameter.

The AutoPump is very versatile and available in a wide range of lengths, valve arrangements, and materials of construction to meet particular site specifications.

Equipment will vary by application and site specifications. (See Chapter 3)

## General Specifications

<b>Pump Diameter:</b>	3.6 inch (91 mm)
<b>Pressure Range:</b>	5 - 120 psi (0.4 - 8.5 Kg/cm )
<b>High Pressure Option:</b>	5 - 200 psi (0.4 - 14.1 Kg/cm )
<b>Flow Ranges:</b>	0-14 gallons per minute (0-53 liters per minute)

## This is How it Works

The AutoPump is a submersible compressed air-driven pump which fills and empties automatically. It also controls the fluid level in a well automatically. The pump fills (**See Figure 1**) when fluids enter either the top or bottom check valve. Air in the pump chamber exits through the exhaust valve as the fluid fills the pump. The float inside the pump is carried upwards by the fluids rising in the casing until it pushes against a stop on the control rod, forcing the valve mechanism to switch to the discharge mode.

The switching of the valve causes the exhaust valve to close and the air inlet valve to open. This causes the pump to empty (**see Figure 1**) by allowing compressed air to enter the pump. This pressure on the fluid closes the inlet check valve and forces the fluids up the discharge line and out of the pump through the outlet check valve. As the fluid level falls in the pump, the float moves downward until it pushes against the lower stop on the control rod, forcing the valve mechanism to switch to the fill mode. The outlet check valve closes and prevents discharged fluids from re-entering the pump. The filling and discharging of the pump continues automatically.

**NOTE:** The figures shown here are simplified schematics.

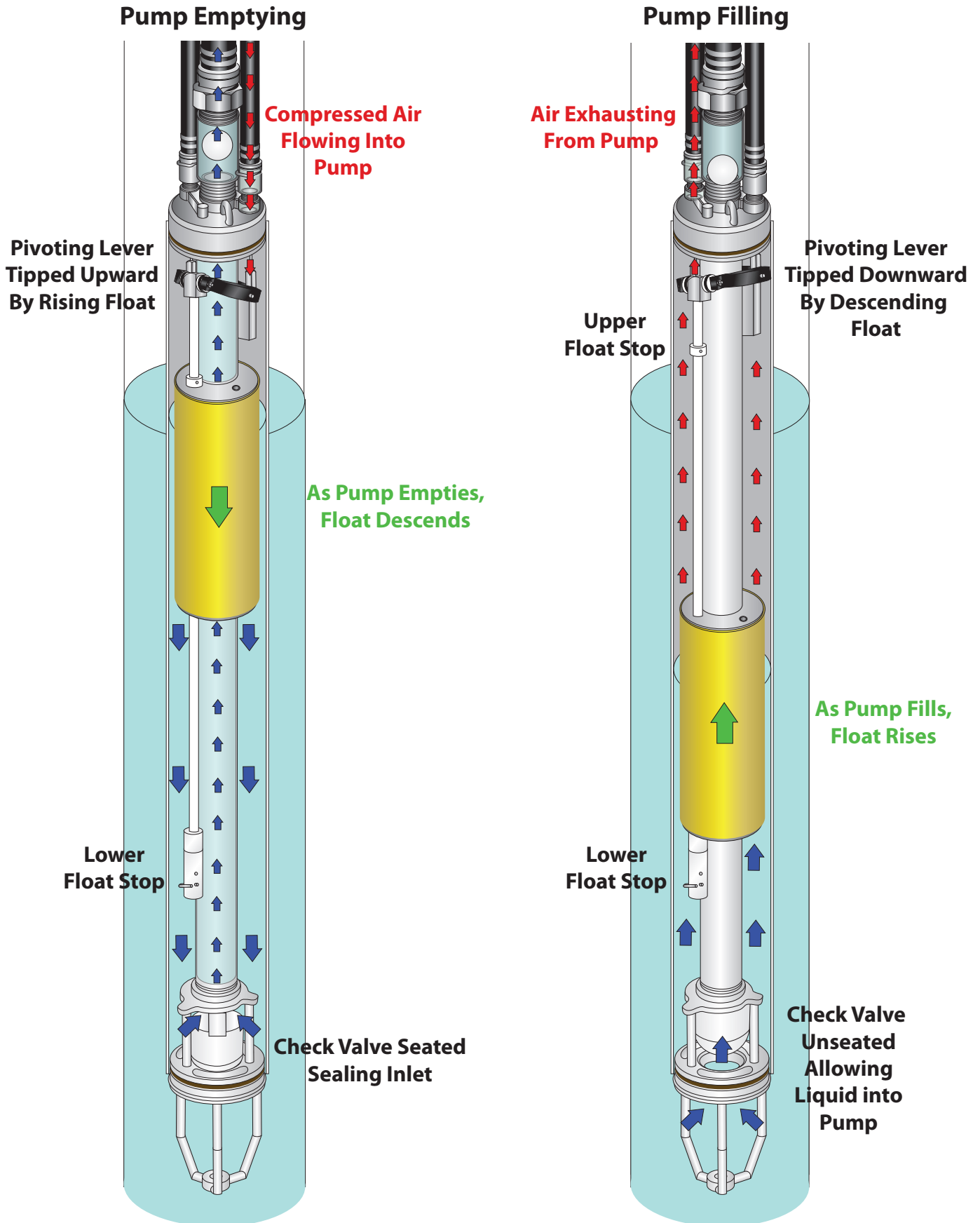

AP4+ System provides everything required for pumping fluid from a well.

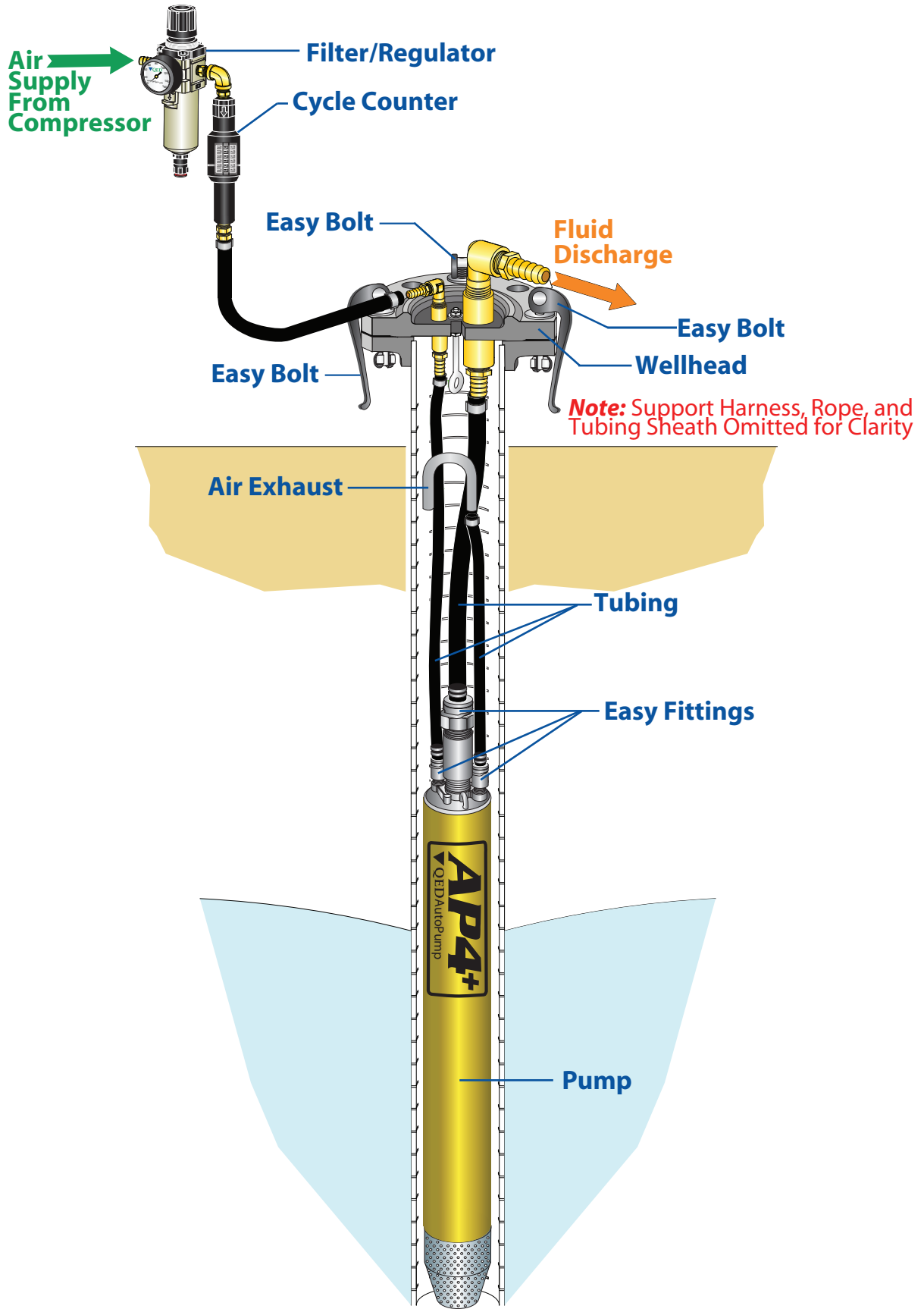

## Unpacking

During the unpacking procedure, check for the following:

- All parts on the packing list have been included in the box
- All fitting openings are unobstructed
- The equipment has not been damaged in shipment

## Equipment List

The equipment list will vary depending on site specifications, but the following list is a typical configuration

1. Top-Loading or Bottom-Loading AP-4 with support harness
2. Single stage filter/regulator with:
  - 5 Micron filter with auto drain tap
  - Pressure regulator with gauge
  - Maximum operating pressure 120 P.S.I. (8.4 Kg/cm )
3. Pump Cycle Counter (PCC)
4. Pump support system:
  - Well cap
  - Polypropylene support rope with quick-link assembly or SS wire rope (Alternate materials as required)

## Single Stage Filter/Regulator

A single stage 5 Micron particulate air filter/regulator has a manual or an optional automatic drain and is installed on the system air supply line. The filter/regulator removes particles and water droplets from the air passing to the AP4+.

**NOTE:** Too much air pressure can result in low pump efficiency

**Figure 3 - Single Stage Filter/Regulator with Quick-Connects**

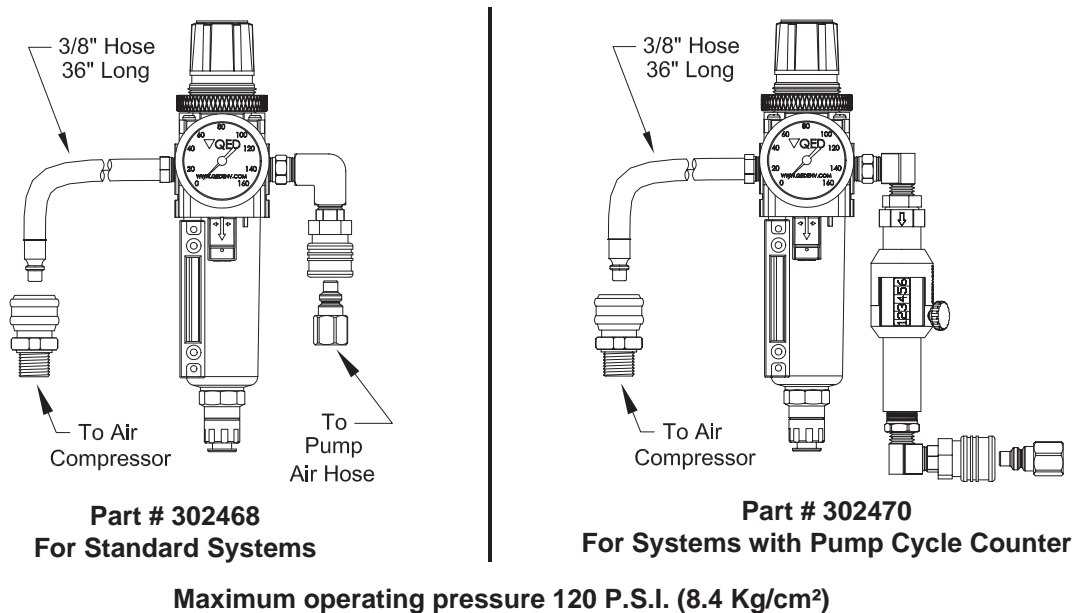

1. Cover the pump tubing/hose ends with tape if they are to be pulled through trenches or laid on the ground. This is to prevent debris from entering the lines.
2. Blow out all water and particles from compressed air conduits (including downwell pump air supply lines) and fluid lines for at least 10 seconds after the water and particles exit before connecting them to the system.
3. Slip clamps over appropriate tubing/hose prior to connecting the tubing/hose to the pump barbs.
4. Push tubing/hose down flush with the fitting's nut (hex) if possible; cover at least three barbs if three or more are present (**Note:** when installing tubing in freezing weather, tubing can be dipped in warm water for a few seconds to soften the nylon).
5. Attach pump support rope/cable to the pump.
6. Attach pump air supply and liquid discharge lines to the well cap. Attach the air exhaust line to the well cap if the pump air is to exhaust outside the well (Note: the liquid discharge line is always the largest diameter of the three lines, and the air supply line is always the smallest diameter).
7. Connect the pump air supply and liquid discharge lines to the appropriate surface lines/headers.

8. Turn on the air pressure to the pump (minimum of 0.5 psi per foot of vertical static head).

**Caution:** Submerging the pump before supplying it with air will result in fluid entering the exhaust tubing/hose. Those fluids will be discharged from the exhaust tubing/hose during the first few cycles of the pump. If this discharge will not be confined to the well; i.e., if the air exhaust line is routed outside the well\*, it is important to make sure that the air exhaust line is not directed such that equipment/ personnel could be splashed by the discharged fluid when air is turned on to the pump.

**Note:** Submerging the pump before supplying it with air can also result in fluid entering the air supply line. This fluid from the well can contain particles, which could interfere with operation of the pump's air valve.

9. Lower the pump to the desired depth in the well.
10. Secure the pump by tying off the pump support line or by placing the well cap (or flange) on the well.
11. Increase the air pressure to the pump until the pump is pushing the fluid out at the desired rate. With sufficient air pressure (at least 10 to 15 psi higher than the vertical static head), the pump will gradually draw down the fluid level in the well to the level of the pump. The time required for this draw down varies with the yield of the well as compared to the flow rate of the pump. The maximum recommended pump operating pressure is 120 psi.

**Note:** If the well environment is such that deposition occurs on stainless steel parts, the operator may wish to raise the pump above the water level during a shutdown of the system.

### \* Routing the air exhaust in vacuum wells:

QED controllerless pumps automatically control the liquid level in the well. Under normal conditions, the liquid level will be maintained at a point approximately one foot below the top of a bottom load pump (this is the pump's actuation point). The pump will automatically start and stop as needed to maintain the level at this actuation point.

When QED controllerless pumps are used in wells that are under vacuum, and the exhaust air is routed into the well, the well level will be maintained at this normal actuation point. If, however, the well is under vacuum and the exhaust air is routed outside of the well (to atmospheric pressure), the actuation point of the pump will be higher than the normal actuation point by a distance equal to the amount of vacuum applied to the well (expressed in "inches of water column"). Please note that the pump will still function normally and maintain the liquid level, albeit a higher level.

## Hose Bundles

Hose bundling or the use of jacketed tubing reduces equipment entanglement at the well surface, and aids the removal of the pump from the well. Bundling also assists in positioning the pump and down-well hose assembly against one side of the well casing. Maximum space is created for other items, such as probes, to be periodically placed inside the well.

Follow these instructions to create a hose bundle:

1. Lay the equipment on the ground and make all of the necessary hose connections. **(See Figure 5).**
2. If a well cap is supplied, install it on the hoses. **(See Figure 4).**
3. Connect the quick-link assembly on the support rope to the eyebolt on the AP4+ and lay the support rope out along with the hoses. Make sure that none of the hoses or support ropes are crossing over each other **(See Figure 5).**

**Note:** To make the next step easier, pull the support rope and the hoses taut.

4. Starting at the AutoPump end of the hose, put a tie-wrap through the center of the braided support rope just above the uppermost quick-connect or barb on the AutoPump **(See Figure 5).**
5. Pulling the rope taut, put the tie-wrap around the fluid discharge hose with the rough surface outwards. Cross the ends and complete the connect the tie-wrap make sure it is straight and is not kinking the hoses **(See Figure 5).**

**Note:** After completing this step, the fluid discharge hose will be attached to the support rope and the exhaust hose. At this point the air supply hose is still lying free.

6. Place the next tie-wrap two feet towards the well cap from the first. Secure the air supply hose rather than the exhaust hose.

**Note:** It is important to put the tie-wraps approximately two feet apart to keep a proper discharge hose/support rope bundle. Experience has shown that spreading the tie-wraps further apart than two feet increases the probability for hose kinking.

7. Continue to alternate the air exhaust and the air supply tie-wraps every two feet, stopping about five feet from the wellhead.
8. Being careful not to leave any sharp edges, cut the excess from the tie-wraps.

You now have a down-well bundled hose assembly that supports both the hoses and the down-well equipment.

**Figure 4 - Examples of Well Caps**

4" or 6" Slip Cap with Holes

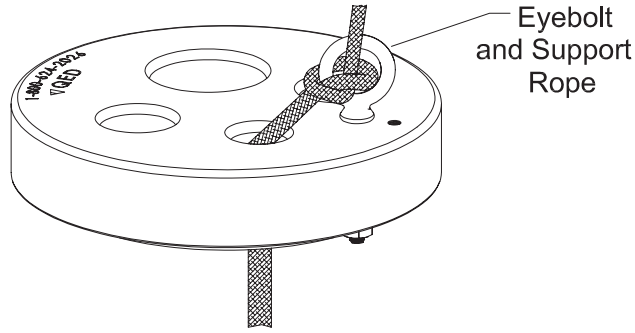

FOR VACUUM APPLICATION

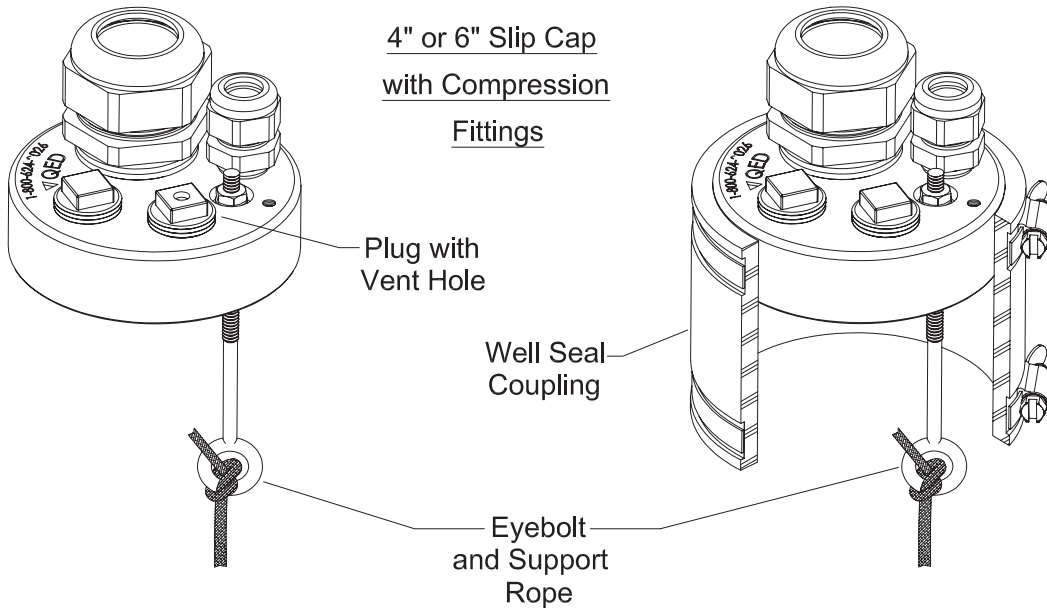

FOR VACUUM APPLICATION

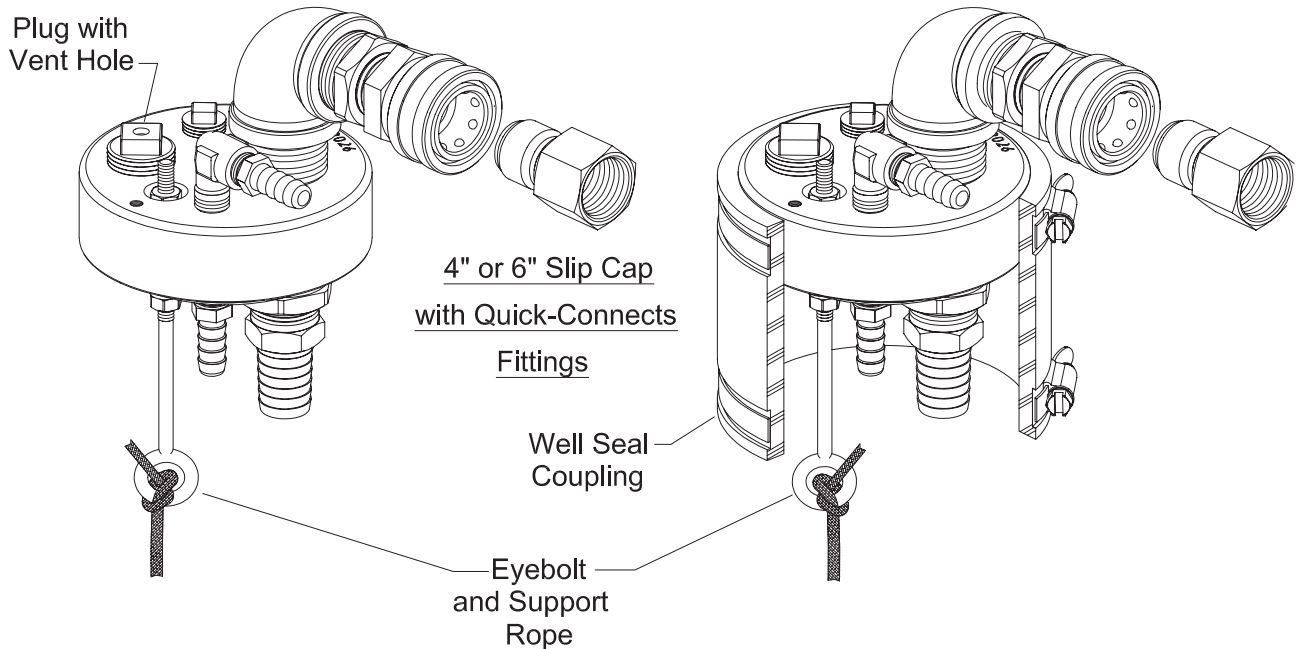



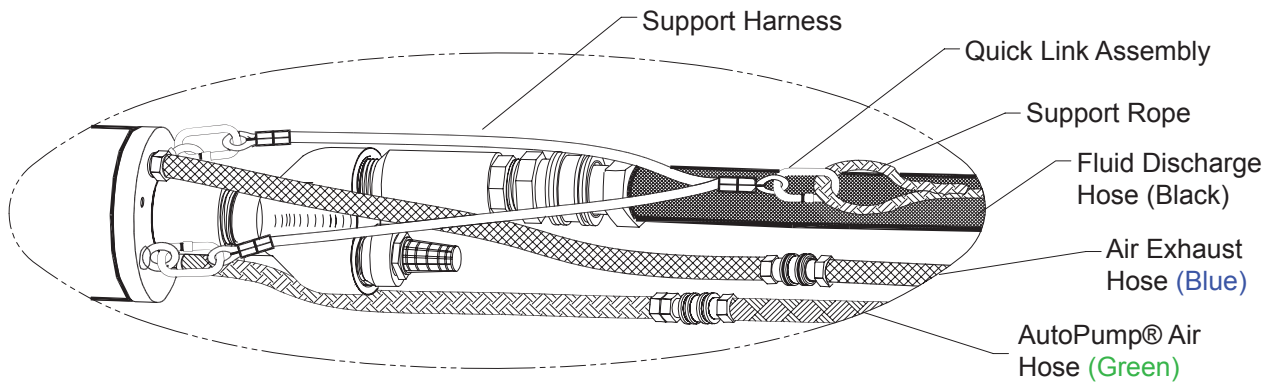

Air Exhaust Tie-Wraps in Between Air Exhaust Tie-Wraps Every 4 Ft. (122 Cm)

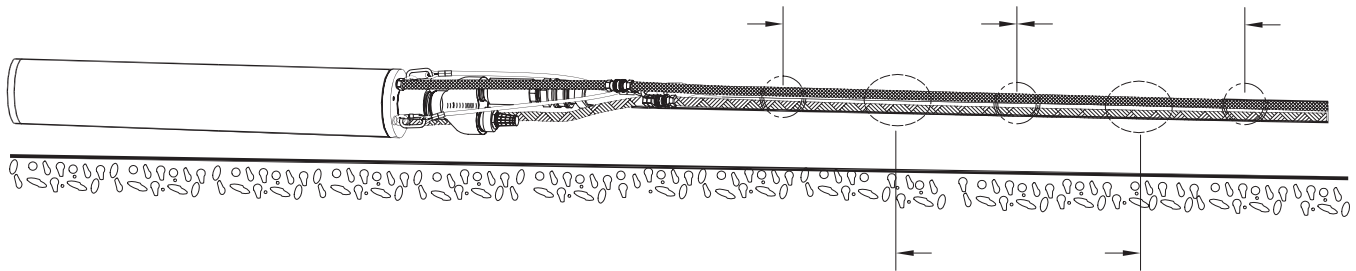

**Tie-Wrap Detail**

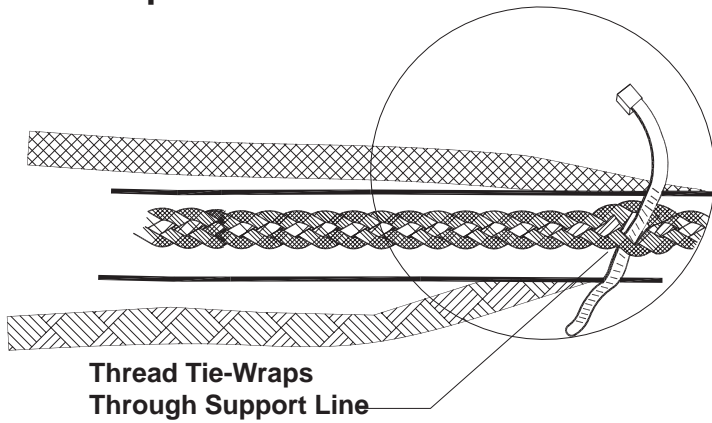

**Air Exhaust Tie-Wrap**

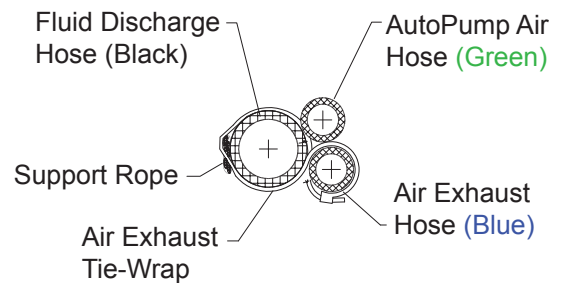

**Air Hose Tie-Wrap**

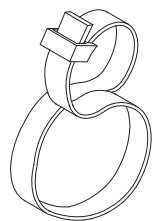
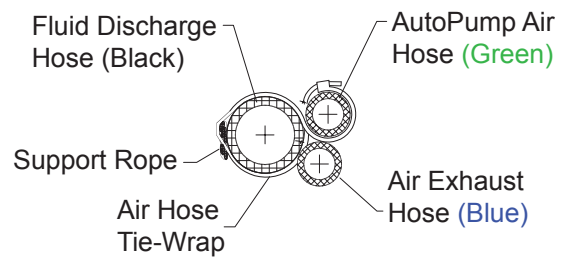

**Figure 8 Tie-Wrap Layout**

## Removing the Pump's Casing

1. Remove the bolt at the bottom of the pump which holds the inlet screen in place (bottom loading pumps only).
2. Remove the three bolts at the bottom of the pump which hold the inlet in place. (**See Figures 6,7,8,and 9**)
3. Remove the inlet from the pump's casing by pulling it out.
4. Twist and slide the casing down off the pump's frame.

## Cleaning Pump Interior

The inner workings of the pump should now be exposed for inspection and cleaning. (**See Figures 6 Through 11**)

**Note:** A Scotch Brite® abrasive pad is useful for cleaning debris from the pump components.

1. Gently brush off built-up solids from the float, the discharge tube, the pump casing and the control rod.
2. The pump can be steam cleaned without damage.
3. Remove thick deposits of hardened scale on the discharge tube by using a handbrush or by lightly tapping the discharge tube with a small hammer. Be careful not to strike any pins or other components, since they may be damaged.

## Iron Build-up Cleaning Procedure

After the casing has been removed from the AutoPump please follow the procedure below:

1. The bottom "spider" should be removed by unthreading it from the pump's discharge pipe. (**See Figures 6,7,8,and 9**)
2. Visually inspect the 1 inch stainless steel fluid discharge pipe for scale build-up or debris. Also, do the same with the float that rides up and down on the SS discharge pipe.
3. Should there be scale deposits on either or both the discharge pipe or float, then remove the float from the SS fluid discharge pipe as follows. (**See Figures 6,7,8,and 9**)

Remove the small SS hairpin from the bottom spring cup. Removing the hairpin and spring cup will allow you to remove the spring, sliding stop and float from the SS discharge pipe.

4. The 1 inch stainless steel fluid discharge pipe can now be cleaned using either a ScotchBrite pad, a wire brush or a wire wheel on either a drill or a grinding machine. After removing the scale/debris, it is recommended the pipe be water rinsed.

Both the internal and external surfaces of the float will generally require cleaning. The cleaning material choices include a Scotch Brite pad, and a light grade 150 sandpaper.

The plates are removed to ease cleaning, they should be replaced on the same float end from which they came. That is, the plates should maintain their original top and bottom positions.

5. The white plastic square Control Rod is the next component to be cleaned. The control rod is the item that fits through the smaller hole in the float and is adjacent to the SS discharge pipe in the assembled pump. To Clean use the Scotch Brite pad or a razor or Exacto knife (not sandpaper).
6. The final component to be cleaned is the outer AP4+ casing. The fastest and most effective way to clean out the inside surface of the pump casing is to use a three-stone honing tool. The technique is to move the hone in-and-out, a half dozen times or so through, each end of the casing. The time for the casing cleaning should take no longer than 5 minutes.

The AutoPump is now ready for re-assembly by following the steps above in reverse order.

**Note:** Before threading the bottom "spider" onto the pump's discharge pipe, be sure to wrap the discharge pipe's threads completely with Teflon tape.

**Note:** Before inserting the two end assemblies back into the pump's casing, apply PTFE grease to the two o-rings (#16 on the next page) to make the next disassembly easier.

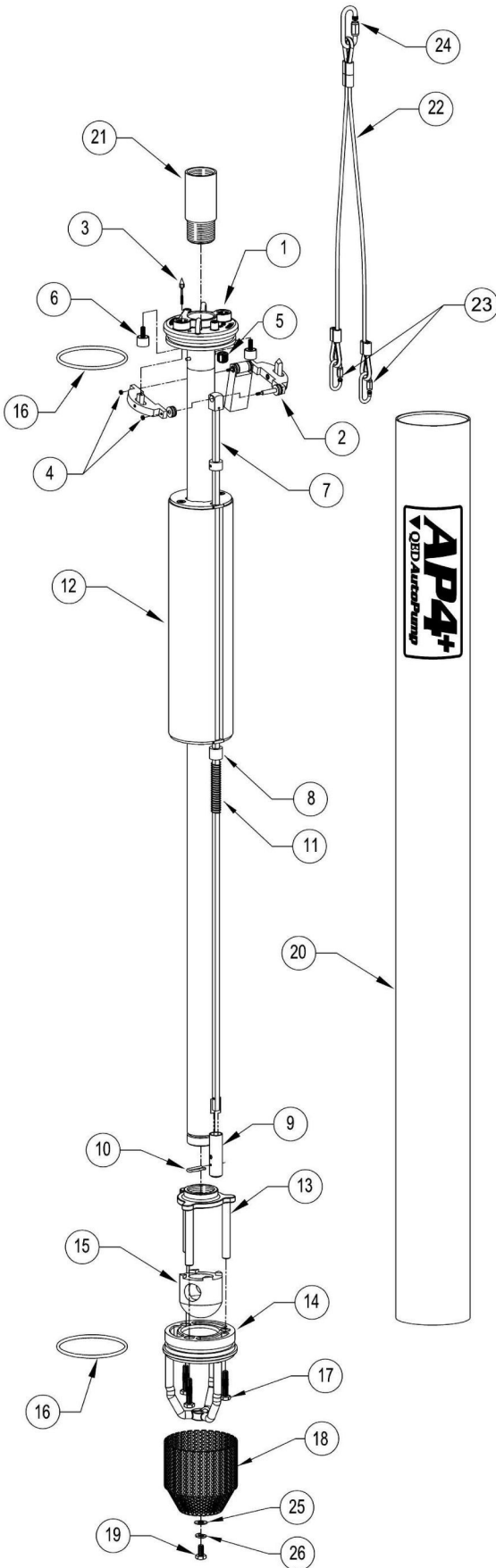

ITEM NO.	PART NUMBER	DESCRIPTION	QTY.
1	303082	FRAME AP4+ LONG 304SS W/120 PSI SEAT AND PIVOT PIN	1
	303083	FRAME AP4+ SHORT 304SS W/120 PSI SEAT AND PIVOT PIN	
2	303203	AP4 LEVERS ASSY PVDF	1
3	200343	POPPET INTAKE 120 PSI AP4 303SS	1
4	200495	NUT SMALL PATTERN, 4-40, LEVER CONNECTOR	2
5	200332	SEAT EXHAUST 120 PSI AP4 303SS	1
6	301083	AP4 212 DEG 316 SS MAGNET W/EPOXY	2
7	303031	CTRL ROD ASSY LONG AP4+	1
	303030	CTRL ROD ASSY SHORT AP4+	
8	201210	AP-4 CONTROL ROD SLIDING STOP PVDF	1
9	201211	AP4 PVDF (KYNAR) SPRING CUP	1
10	206247	HAIRPIN, AP4 CTRL ROD/SPRING CUP PIN HASTELLOY C-276	1
11	200351	SPRING AP4 CTRL ROD HASTELLOY C-276	1
12	300721	FLOAT ASSY AP-4	1
13	206189	SPIDER, CASTING - AP4+ MACHINED 304LS	1
14	206193	INLET, CASTING-AP4+ MACHINED 304L SS	3
15	206417	PLUG BCV INTAKE AP4 BL UHMW-PE	1
16	206273	O-RING PARKER VITON 2-235 V747-75	2
17	206362	SCREW, 1/4"-20 X 1-1/4" FL/THR HEX CAP, W/VIT, W/VIBRA-TITE	3
18	206198	SCREEN ANGLE, AP4+ 316LS	1
19	206253	SCREW, 1/4-20 X 1/2" LONG HEX HD CAP - 18-8 SS	1
20	206283	CASING, FRP AP4+ LONG LABELED	1
	206284	CASING, FRP AP4+ SHORT LABELED	
21	205599	HOUSING CHECK DISCHARGE BRASS	1
22	300585	HARNES SUPP W/CU SLEEVE 304SS	1
23	206090	QUICK LINK 3/16" 18-8 SS	2
24	206091	QUICK LINK 1/4" 18-8 SS	1
25	206437	FLAT WASHER 1/4" 316 SS	1
26	201783	WASHER SPLIT LOCK 1/4" 18-8 SS	1

NOTE: Some Parts are available in alternate materials based on site specific applications

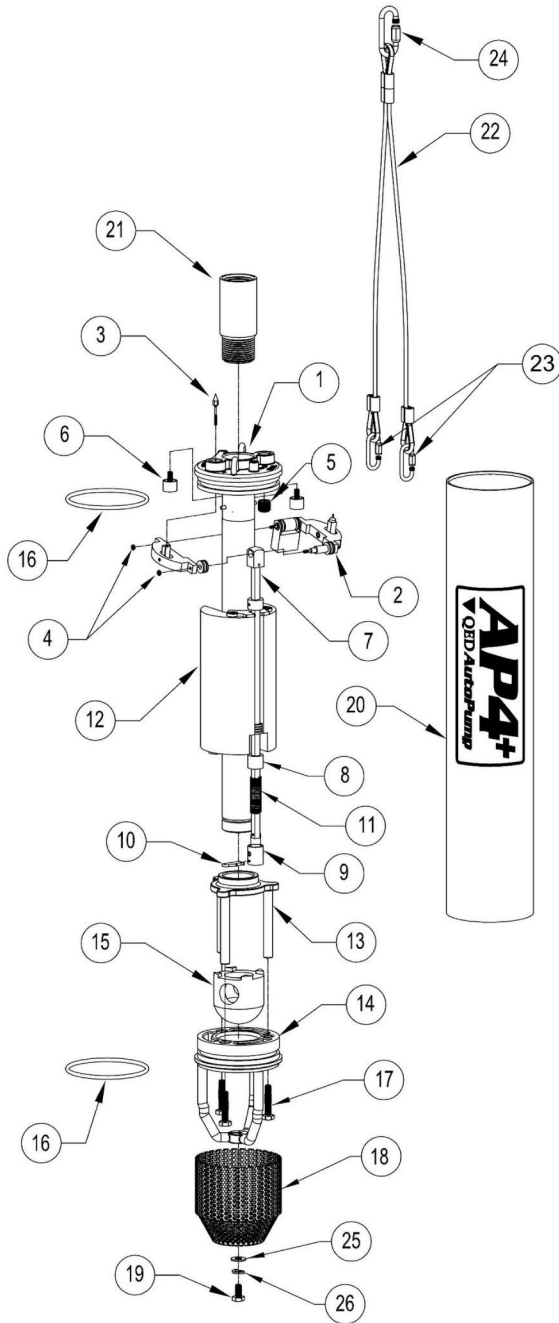

ITEM NO.	PART NUMBER	DESCRIPTION	QTY.
1	303084	FRAME AP4+ LDD 304SS W/200 PSI SEAT AND PIVOT PIN	1
2	303205	LEVERS ASSY, PVDF AP4 LOW DRAW DOWN	1
3	200664	POPPET INTAKE 200 PSI AP4 303SS	1
4	200495	NUT SMALL PATTERN, 4-40, LEVER CONNECTOR	2
5	203037	SEAT EXHAUST AP4 LDD 303SS	1
6	303001	AP4 150 DEG 316 SS MAGNET W/EPOXY	2
7	303053	CTRL ROD ASSY LDD AP4+	1
8	201210	AP-4 CONTROL ROD SLIDING STOP PVDF	1
9	201664	AP4D CONTROL SPRING CUP PVDF	1
10	206247	HAIRPIN, AP4 CTRL ROD/SPRING CUP PIN HASTELLOY C276	1
11	201628	SPRING CTRL ROD AP4 LDD 316SS	1
12	302598	FLOAT, AP4LD A-1	1
13	206189	SPIDER, CASTING - AP4+ MACHINED 304LS	1
14	206193	INLET, CASTING-AP4+ MACHINED 304L SS	3
15	206417	PLUG BCV INTAKE AP4 BL UHMW-PE	1
16	206273	O-RING PARKER VITON 2-235 V747-75	2
17	206252	SCREW, 1/4"-20 X 1-1/4" FL/THR HEX CAP, W/VIT, W/VIBRA-TITE	3
18	206198	SCREEN ANGLE, AP4+ 316LS	1
19	206253	SCREW, 1/4-20 X 1/2" LONG HEX HD CAP - 18-8 SS	1
20	206285	CASING, FRP AP+ LDD LABELED	1
21	205599	HOUSING CHECK DISCHARGE BRASS	1
22	300585	HARNES SUPP W/CU SLEEVE 304SS	1
23	206090	QUICK LINK 3/16" 18-8 SS	2
24	206091	QUICK LINK 1/4" 18-8 SS	1
25	206437	FLAT WASHER 1/4" 316 SS	1
26	201783	WASHER SPLIT LOCK 1/4" 18-8 SS	1

NOTE: Some Parts are available in alternate materials based on site specific applications



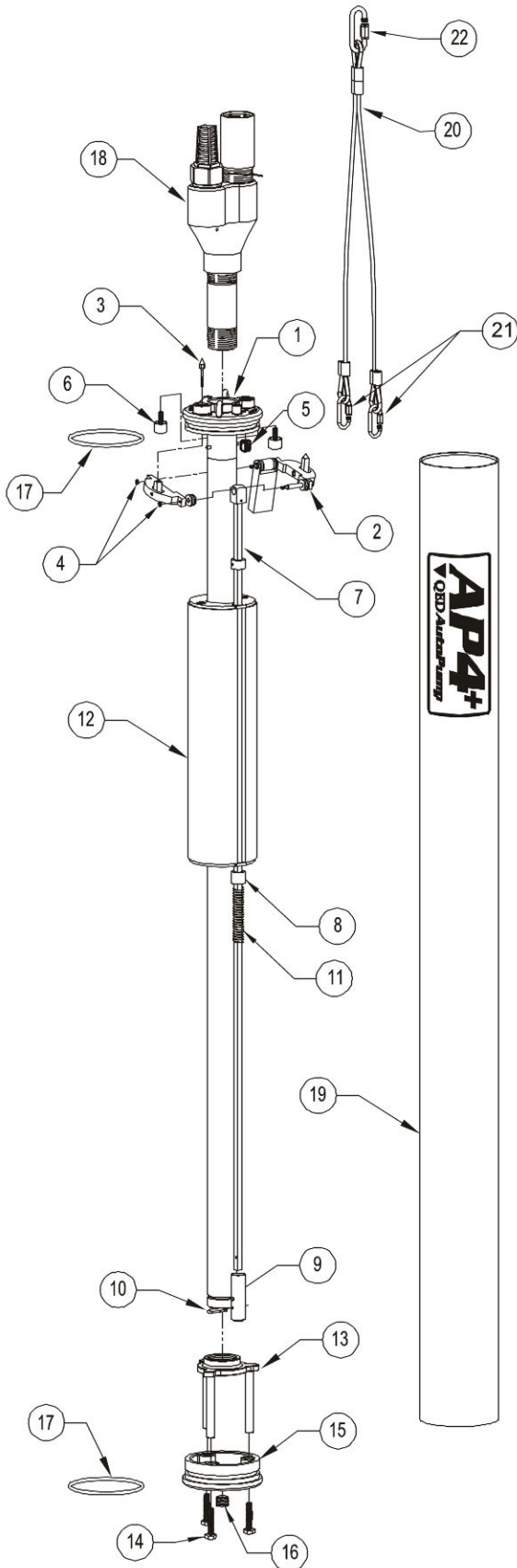

ITEM NO.	PART NUMBER	DESCRIPTION	QTY.
1	303082	FRAME AP4+ LONG 304SS W/120 PSI SEAT AND PIVOT PIN	1
	303083	FRAME AP4+ SHORT 304SS W/120 PSI SEAT AND PIVOT PIN	
2	303203	AP4 LEVERS ASSY PVDF	1
3	200343	POPPET INTAKE 120 PSI AP4 303SS	1
4	200495	NUT SMALL PATTERN, 4-40, LEVER CONNECTOR	2
5	200332	SEAT EXHAUST 120 PSI AP4 303SS	1
6	301083	AP4 212 DEG 316 SS MAGNET W/EPOXY	2
7	303031	CTRL ROD ASSY LONG AP4+	1
	303030	CTRL ROD ASSY SHORT AP4+	
8	201210	AP-4 CONTROL ROD SLIDING STOP PVDF	1
9	201211	AP4 PVDF (KYNAR) SPRING CUP	1
10	206247	HAIRPIN, AP4 CTRL ROD/SPRING CUP PIN HASTELLOY C276	1
11	200351	SPRING AP4 CTRL ROD HASTELLOY C-276	1
12	300721	FLOAT ASSY AP-4	1
13	206189	SPIDER, CASTING - AP4+ MACHINED 304LS	1
14	206362	SCREW, 1/4"-20 X 1-1/4" FL/THR HEX CAP, W/VIT, W/VIBRA-TITE	3
15	206263	INLET, CASTING-MACHINED AP4+ TOP FILL 304LSS	1
16	206290	PLUG, 1/4" 316SS COUNTERSUNK HEX	1
17	206273	O-RING PARKER VITON 2-235 V747-75	2
18	303056	AP4+TL WYE ASSY W/BRASS DCV, HDPE SCREEN	1
19	206283	CASING, FRP AP4+ LONG LABELED	1
	206284	CASING, FRP AP4+ SHORT LABELED	
20	300585	HARNESS SUPP W/CU SLEEVE 304SS	1
21	206090	QUICK LINK 3/16" 18-8 SS	2
22	206091	QUICK LINK 1/4" 18-8 SS	1

NOTE: Some Parts are available in alternate materials based on site specific applications

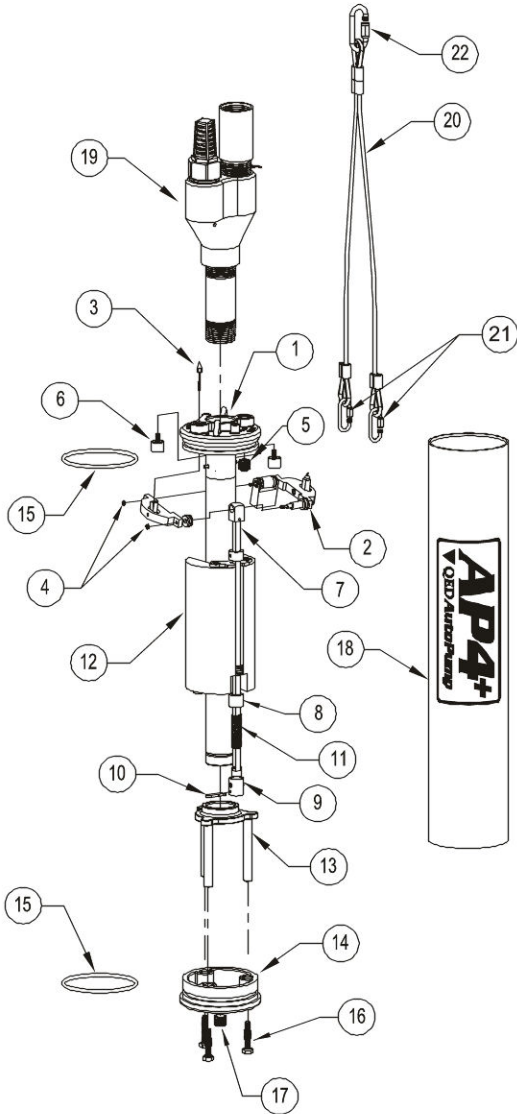

ITEM NO.	PART NUMBER	DESCRIPTION	QTY.
1	303084	FRAME AP4+ LDD 304SS W/200 PSI SEAT AND PIVOT PIN	1
2	303205	LEVERS ASSY, PVDF AP4 LOW DRAW DOWN	1
3	200664	POPPET INTAKE 200 PSI AP4 303SS	1
4	200495	NUT SMALL PATTERN, 4-40, LEVER CONNECTOR	2
5	203037	SEAT EXHAUST AP4 LDD 303SS	1
6	303001	AP4 150 DEG 316 SS MAGNET W/EPOXY	2
7	303053	CTRL ROD ASSY LDD AP4+	1
8	201210	AP-4 CONTROL ROD SLIDING STOP PVDF	1
9	201664	AP4D CONTROL SPRING CUP PVDF	1
10	206247	HAIRPIN, AP4 CTRL ROD/SPRING CUP PIN HASTELLOY C276	1
11	201628	SPRING CTRL ROD AP4 LDD 316SS	1
12	302598	FLOAT, AP4LD A-1	1
13	206189	SPIDER, CASTING - AP4+ MACHINED 304LS	1
14	206362	INLET, CASTING-MACHINED AP4+ TOP FILL 304L SS	1
15	206273	O-RING PARKER VITON 2-235 V747-75	2
16	206252	SCREW, 1/4"-20 X 1-1/4" FL/THR HEX CAP, W/VIT, W/VIBRA-TITE	3
17	206290	SCREEN ANGLE, AP4+ 316LS	1
18	206285	CASING, FRP AP+ LDD LABELED	1
19	303056	AP4+TL WYE ASSY W/BRASS DCV, HDPE SCREEN	1
20	300585	HARNESS SUPP W/CU SLEEVE 304SS	1
21	206090	QUICK LINK 3/16" 18-8 SS	2
22	206091	QUICK LINK 1/4" 18-8 SS	1

NOTE: Some Parts are available in alternate materials based on site specific applications

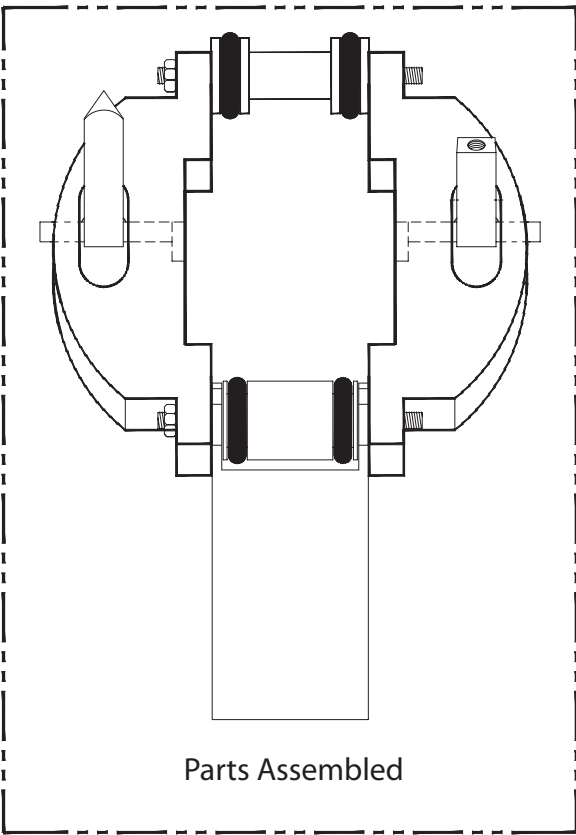
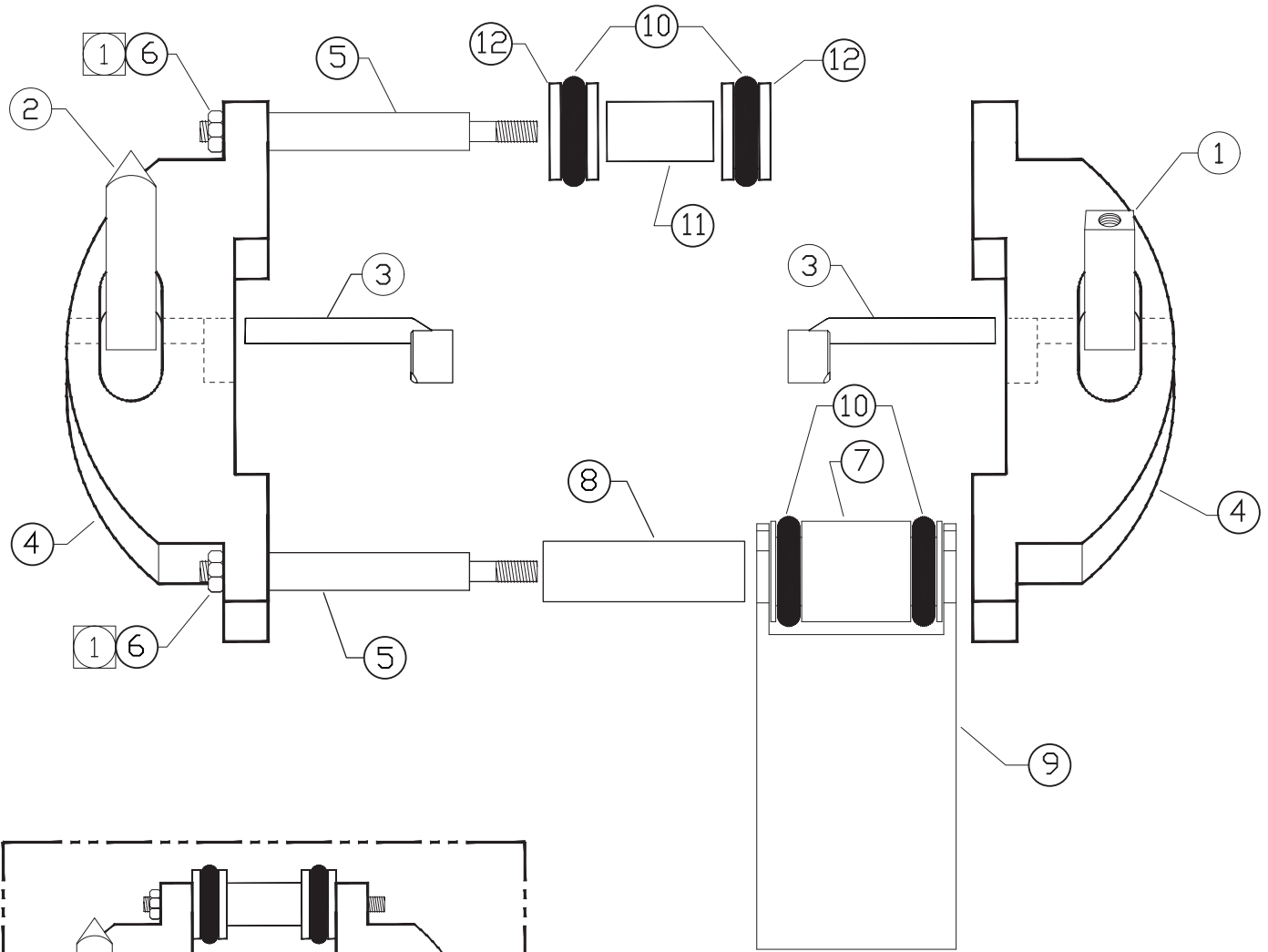

ITEM NO.	PART NUMBER	DESCRIPTION	QTY.
1	200359	120 PSI INTAKE POPPET CONNECTOR-LONG	1
1	200359	120 PSI INTAKE POPPET CONNECTOR-SHORT	1
1	200665	120 PSI INTAKE POPPET CONNECTOR-LDD	1
2	200337	303 SS 120 PSI EXHAUST POPPET-LONG	1
2	200337	303 SS 120 PSI EXHAUST POPPET-SHORT	1
2	200336	303 SS 120 PSI EXHAUST POPPET-LDD	1
3	206445	NITRONIC 60 POPPET PIN-BUSHING	2
4	201033	LEVER HALF	2
5	200328	303 SS LEVER CONNECTING PIN	2
6	200495	4-40 SS SMALL PATTERN NUT LEVER CONNECTING	4
7	200330	17-7 COUNTERWEIGHT ROLLER	1
8	201053	316 SS COUNTERWEIGHT BUSHING	1
9	200327	303 SS COUNTERWEIGHT-LONG	1
9	200327	303 SS COUNTERWEIGHT-SHORT	1
9	206008	303 SS COUNTERWEIGHT-LDD	1
10	200496	VITON BUMPER O-RING	4
11	201052	316 SS CONTROL ROD ADAPTER BUSHING	1
12	201458	PVDF CONTROL ROD ROLLER	2

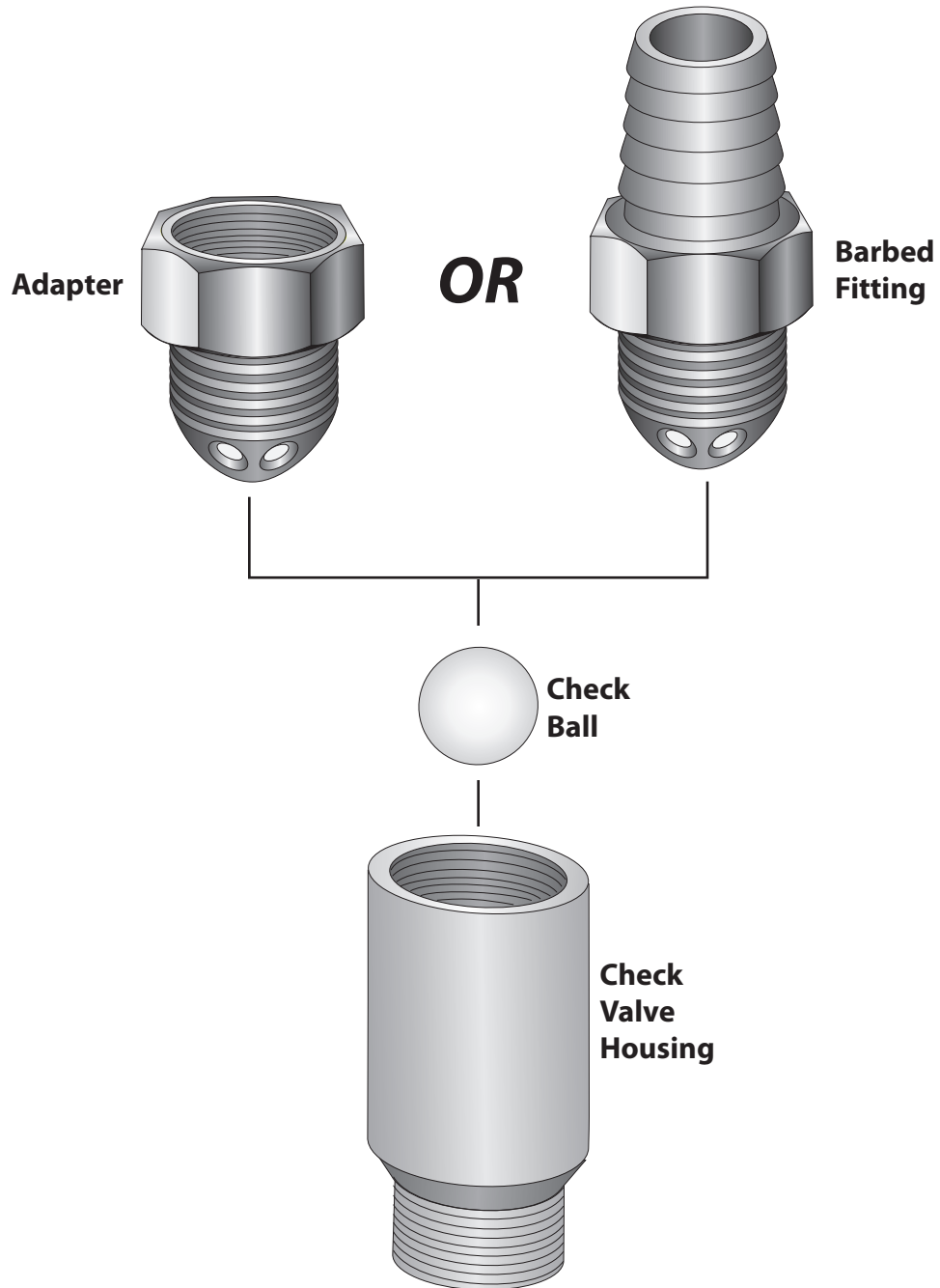



Problems may occur and usually can be easily resolved by following these instructions. If, after careful reading and service, you cannot resolve the problem, please contact the QED Environmental Systems (QED) Service Department at **(800) 537-1767**.

**Caution:** Wear goggles, gloves, and coveralls when servicing this system. After troubleshooting is completed and before assembling the pump, slowly move the float through its range to ensure that the lever will trip even if the pump fills and empties slowly.

**Note:** Maintenance for disassembly and cleaning instructions.

Possible Causes Detailed Instructions Follow this Chart	Symptoms		
	Pump not cycling	Pump cycles, but volume is reduced or there is no discharge	Air in fluid discharge
1. Air supply	X		X
2. Fluid level	X		
3. Air exhaust restricted	X		X
4. Fluid inlet clogged	X		
5. Debris, scale or very viscous fluid	X	X	X
6. Lever pivot wear	X		X
7. Debris in air inlet valve	X		
8. Fluid check valve		X	
9. Valve timing	X		

## Troubleshooting

### 1. Air Supply

- If the air pressure is too low, or if the flow is severely restricted, the pump will not cycle. The minimum air pressure requirement for pump operation is 0.5 psi per foot of vertical static head.
- If the air pressure exceeds the design limitations of the pump, the pump may fail to cycle, or the exhaust may have locked up and caused air to enter the fluid discharge.

### 2. Fluid Level

- The fluid level must be above the fluid inlet on a Top-Loading pump. On a Bottom-Loading pump, the fluid must be no lower than 9 inches below the head of the pump

### 3. Air Exhaust Restricted

- The exhaust line must not be kinked, plugged, or too small in diameter.
- The air exhaust outlet must be above the fluid level
- If the air exhausts in the well, the well must be vented to the atmosphere or a functioning vapor recovery line.

- If the air exhausts to the atmosphere (outside the well) and a vacuum is drawn on the well, the pump may fail to fill. In order for the pump to fill under these conditions, the pump must be submerged to make up for the pressure difference between the atmosphere and the partial vacuum in the well.

The pressure difference, expressed as feet of water column (FT. W. C.), is the distance the fluid must be above the pump before it can fill.

#### 4. Fluid Inlet Clogged

- If the fluid inlet screen is clogged with debris water cannot enter the pump.

#### 5. Debris, Scale, or very Viscous Fluid

- If debris, scale or a very viscous fluid has accumulated inside the pump, the float may not move freely up and down, or the control rod may not slide easily through the float.
- Clean the float, control rod, and the casing. (*See Chapter 5 for cleaning instructions*).

#### 6. Lever Pivot Wear

- Grasp the center of the lever with thumb and forefinger. Rotate the lever to horizontal.
- Push up and down, toward and away from the head. Confirm that there is less than 1/32 inch of movement.
- Replace the levers if the pivot hole is worn

#### 7. Debris in Air Inlet Valve (*First check #6-Lever Pivot Wear*)

- Open the pump. Connect the air supply. Pull the control rod down. Listen to determine if air leaks through. If air still leaks through the valve with the control rod down, the air tubing must be removed to access the valve inlet to check for debris in the valve. Clean the valve by blowing air or water through it from both ends.
- Push the rod upwards. If little or no air passes through, remove the tubing to access the valve inlet. Blow air through the valve from the poppet side to clear debris from the poppet.

#### 8. Fluid Check Valves

- Open the pump. Hold the pump vertically and pour water into the discharge check valve. If water flows through, clean the valve.
- Remove the valve and use emery cloth or a very fine sand paper to polish the surface where the ball seats.
- If the pump is a Bottom-Loading design, inspect the seat of the bottom check valve for debris and wear. Clean or replace if necessary.
- If the pump is a Top-Loading design, remove the fluid inlet check valve and inspect the seating surface and the ball for debris and wear.

#### 9. Air Inlet Valve Timing

- (First check lever pivot wear per #6 above)
- Call the QED Service Department for correct air valve timing for your pump.

## Returning Equipment for Service

If the equipment needs to be returned to QED for servicing, please follow these steps:

1. Call the QED Service Department and obtain a Return Material Authorization (RMA) number. Please have available the contact person's name, company name and address, phone number, fax number, reason for the return, and the names of the chemicals to which the equipment has been exposed.
2. Clean all equipment before shipping. (**See *Equipment Cleaning Requirements at the end of this section***). If the equipment must be cleaned after it arrives at QED, the customer will be charged for the cleaning and disposal of material, if necessary. (Cost can be \$500.00 per piece of equipment cleaned.) It is also important to note that shipping equipment with a known hazardous waste is a *violation of federal law*. Drain and dry all equipment after cleaning.
3. Package the equipment so that it will not be damaged in shipment. Use bubble pack rather than styrofoam flakes as packing material.
4. Ship the equipment via a carrier and service level (i.e., one-day, two-day shipping) in consideration of probable service time and return shipment time.
5. It is recommended that such shipments be insured so, if the shipment is badly damaged or lost, the customer can replace the equipment at little or no cost.
6. Include the contact's name, company, phone number and RMA number given by QED.
7. Write the RMA number on the outside of the packaging so it will be directed immediately to the QED Service Department.

## Equipment Cleaning Requirements

If the equipment is to be shipped to another site or to the factory for service, it needs to be thoroughly cleaned before leaving the site. Cleaning the equipment protects the user (sender), the shipper, and the receiver from dirt and/or contaminants. If the equipment is not cleaned prior to shipping for servicing, it may be severely delayed, refused or the shipper may be charged a cleaning fee. Before packing and shipping, ensure that the equipment is dry inside and out.

### To Clean the AP4+:

1. Pump clean water or water with a gentle soap solution (e.g. Dove Dish Soap) through the pump to remove free product and particles.
2. Rinse all soap off of the equipment.
3. Soak and rinse the outside of the unit with water to remove loose debris and dirt.
4. Steam clean inside and out to remove difficult dirt and contaminants.

**Caution:** Use low pressure (less than 40 psi) when steam cleaning.

# AP4+B

**Max. Flow** 14 gpm (53 lpm)

**O.D.** 3.6 in (91 mm)

**Length** 51.4 in. (131cm)

## Advantages

1. **The original automatic air-powered well pump, proven worldwide over 23 years**
2. **The highest flow rates and deepest pumping capabilities in the industry**
3. **Patented, proven design for superior reliability and durability, even in severe applications**
4. **Handles solids, solvents, hydrocarbons corrosive conditions, viscous fluids and high temperatures beyond the limits of electric pumps**
5. **Five-year warranty**



## Description

The AP4+ Bottom Inlet Long AutoPump provides maximum capabilities and flow in a bottom inlet pump for 4" (100 mm) diameter and larger wells with shorter water columns and/or the need to pump down to lower water levels, compared to full-length pumps. It is offered in optional versions to handle even the most severe remediation and landfill pumping applications, and delivers flow rates up to 14 gpm (49 lpm)\*. The AP4+ Long Bottom Inlet AutoPump is complemented by the most comprehensive selection of accessories to provide a complete system to meet site specific requirements. Call QED for prompt, no-obligation assistance on your pumping project needs.

## The AutoPump Heritage

The AP4+ Bottom Inlet Long AutoPump is part of the famous AutoPump family of original automatic air-powered pumps, developed in the mid 1980s specifically to handle unique pumping needs at remediation and landfill sites. Over the years they've proven their durability at thousands of sites worldwide. AutoPumps are designed to handle difficult pumping challenges that other pumps can't, such as hydrocarbons, solvents, suspended solids, corrosives, temperature extremes, viscous fluids and frequent start/stop cycles. Beyond just the pump, AutoPump systems offer the most complete range of tubing, hose, connectors, wellhead caps and accessories to help your installation go smoothly. This superior pumping heritage, application experience and support back up every AutoPump you put to work on your project.

# AP4 + B

## Pump Dimensions

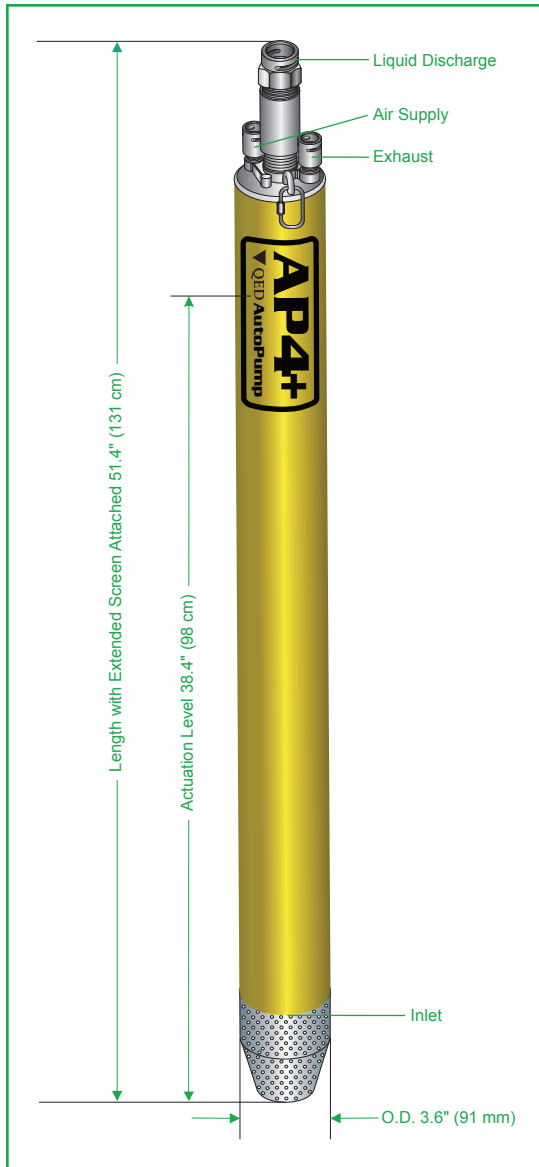

## Specifications & Operating Requirements

<b>Model</b>	<b>4" - Long AP4+ Bottom Inlet</b>
<b>Liquid Inlet Location</b>	Bottom
<b>O.D.</b>	3.6 in. (91 mm)
<b>Overall Length With Extended Screen</b>	51.4 in. (131 cm)
<b>Weight</b>	16.7 lbs. (7.6 kg)
<b>Maximum Flow Rate</b>	14 gpm (53 lpm)* - See Flow Rate Chart
<b>Pump Volume/Cycle</b>	0.58 - 0.78 gal (2.2 - 3L)
<b>Minimum Accuation Level</b>	38.4 in. (98 cm)
<b>Standard Pump</b>	
<b>Maximum Depth</b>	250 ft. (76 m)
<b>Air Pressure</b>	5 - 120 psi (0.4 - 8.4 kg/cm2)
<b>Air Usage</b>	0.4 - 1.1 scf / gal. (3.0 - 8.5 liter of air / fluid liter) - See air usage chart
<b>High Pressure Pump</b>	
<b>Maximum Depth</b>	425 ft. (130 m)
<b>Air Pressure</b>	5 - 200 psi (0.4 - 14.1 kg/cm2)
<b>Minimum Liquid Density</b>	0.7 SpG (0.7 g/cm3)
<b>Standard Construction Materials<sup>1</sup></b>	
<b>Pump Body</b>	Fiberglass or Stainless Steel
<b>Pump Ends</b>	Stainless Steel
<b>Internal Components</b>	Stainless Steel, Viton, PVDF <sup>2</sup> , Hastelloy-C
<b>Tube &amp; Hose Fittings</b>	Brass or Stainless Steel
<b>Fitting Type</b>	Barbs, Quick Connects or Easy Fittings
<b>Tube &amp; Hose Options</b>	
<b>Tubing Materials<sup>2</sup></b>	Nylon
<b>Sizes - Liquid Discharge</b>	1 in. (25 mm) or 1-1/4 in. (32 mm) OD
<b>Pump Air Supply</b>	1/2 in. (13 mm) OD
<b>Air Exhaust</b>	5/8 in. (16 mm) OD
<b>Hose Material</b>	Nitrile
<b>Sizes - Liquid Discharge</b>	3/4 in. (19 mm) or 1 in. (25 mm) ID
<b>Pump Air Supply</b>	3/8 in. (9.5 mm) ID
<b>Air Exhaust</b>	1/2 in. (13 mm) ID

<sup>1</sup> Material upgrades available  
<sup>2</sup> Applies to QED supplied tubing; other tubing sources may not conform to QED fittings.

## Application Limits (Base model)

AP4+ AutoPumps are designed to handle the application ranges described below. For applications outside these ranges, consult QED about AP4+ upgrades.

**Maximum Temperature:** 180°F (82°C)

**pH Range:** 4-9

**Solvents and Fuels:** diesel, gasoline, JP1-JP6, #2 heating oils, BTEX, MTBE, landfill liquids

\*Consult QED for higher flow requirements

Long and short AP4+ AutoPumps are warranted for five(5) years: Low-Drawdown AP4+ AutoPumps are warranted for one (1) year.

# AP4 + B

## Flow Rates<sup>1</sup>

**3/4 inch (19 mm)  
Inside Diameter Discharge Hose  
(Equivalent to 1-Inch O.D. Tubing)**

**1 inch (25.4 mm)  
Inside Diameter Discharge Hose  
(Equivalent to 1.25-Inch O.D. Tubing)**

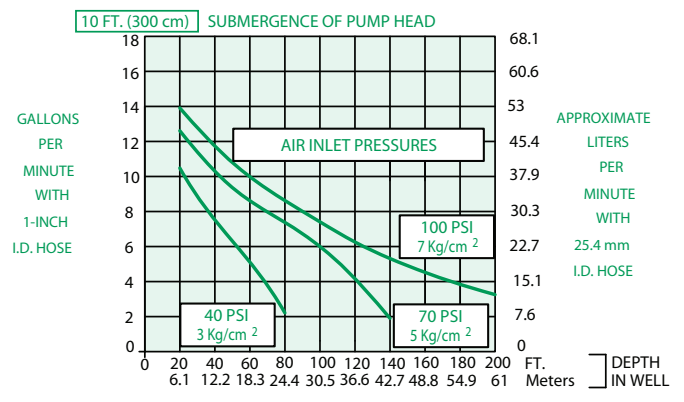
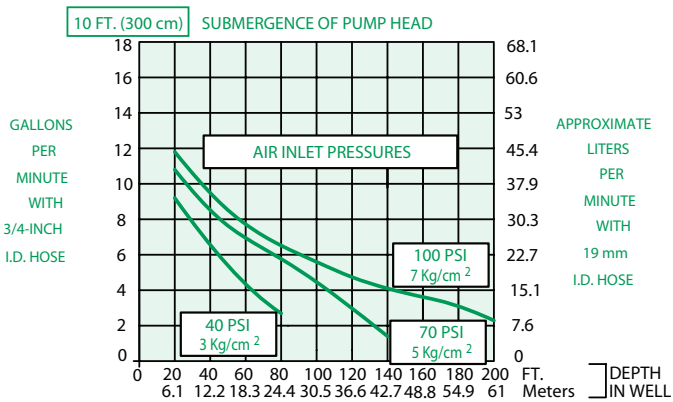
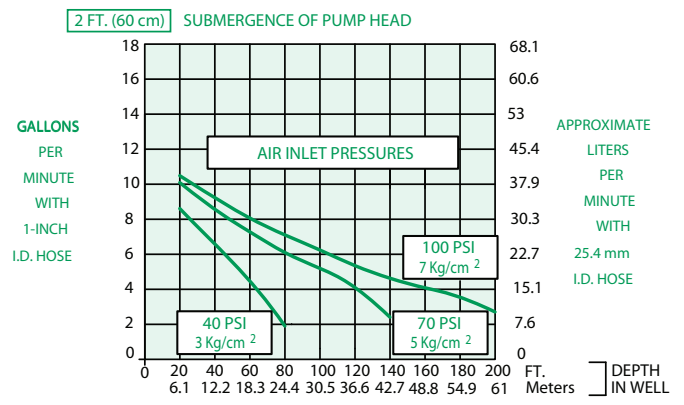
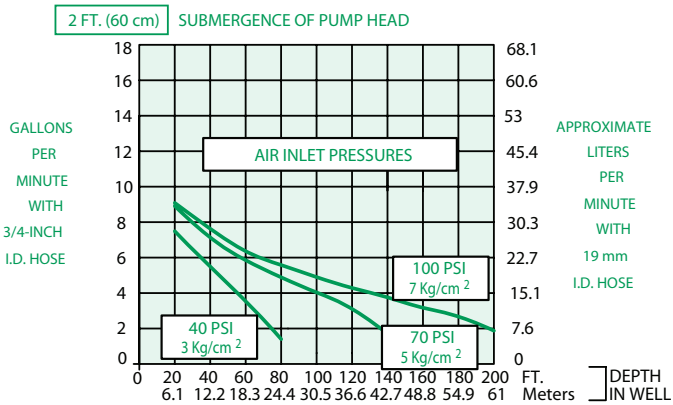
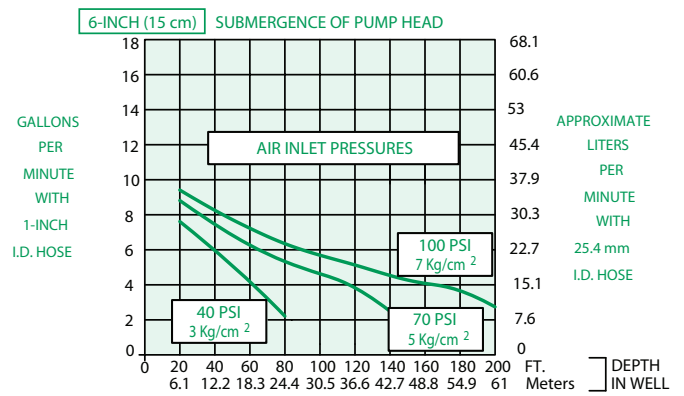
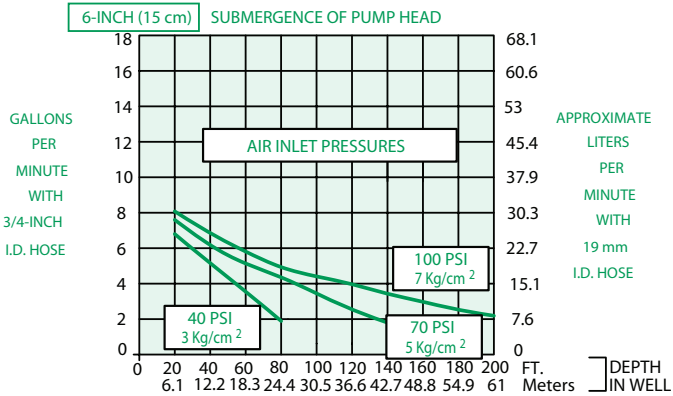

<sup>1</sup>FLOW RATES MAY VARY WITH SITE CONDITIONS. CALL QED FOR TECHNICAL ASSISTANCE.

# AP4+B



STANDARD  
CUBIC FEET OF AIR  
PER  
GALLON PUMPED  
(SCF/GAL)

STANDARD  
CUBIC FEET OF AIR  
PER  
GALLON PUMPED  
(SCF/GAL)

## Air Consumption

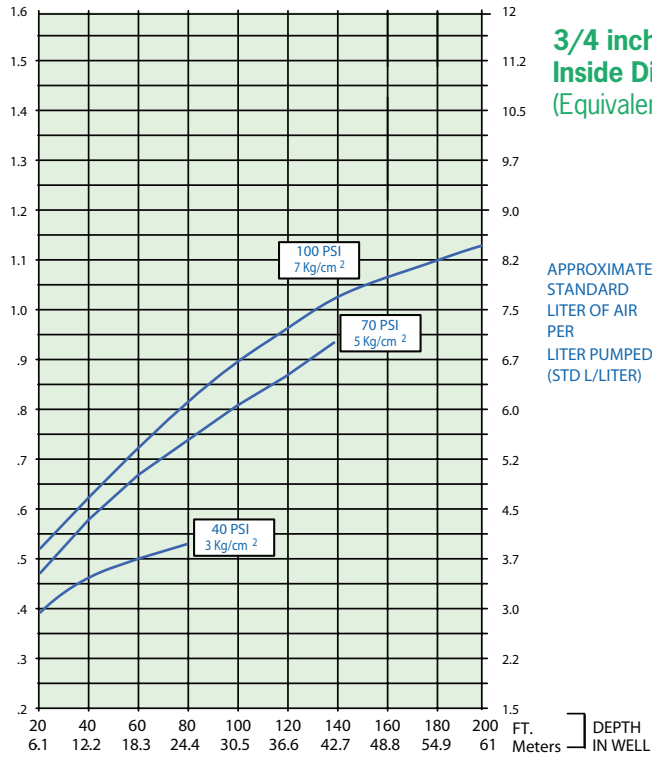

APPROXIMATE  
STANDARD  
LITER OF AIR  
PER  
LITER PUMPED  
(STD L/LITER)

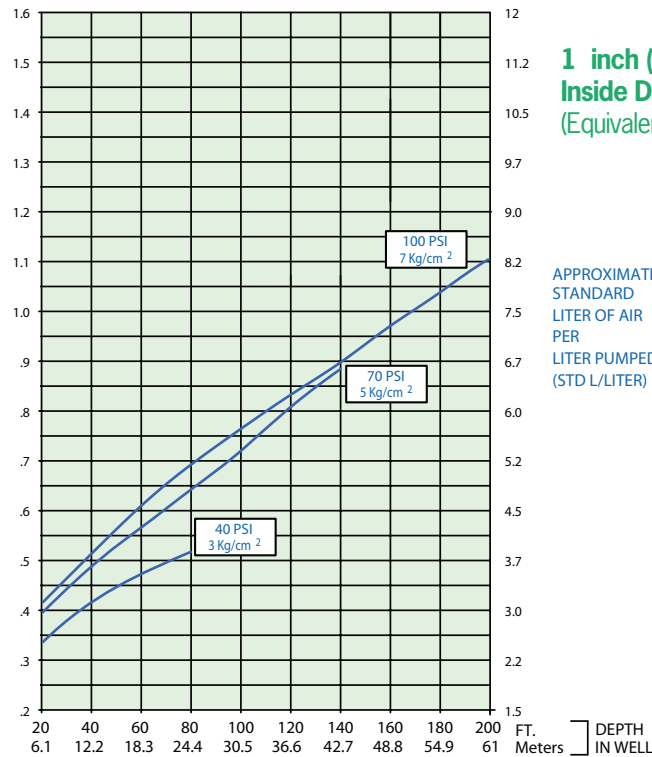

APPROXIMATE  
STANDARD  
LITER OF AIR  
PER  
LITER PUMPED  
(STD L/LITER)

## AP4+B

**Max. Flow** 13 gpm (49 lpm)

**O.D.** 3.6 in (91 mm)

**Length** 39.3 in. (100 cm)

### Advantages

1. **The original automatic air-powered well pump, proven worldwide over 23 years**
2. **The highest flow rates and deepest pumping capabilities in the industry**
3. **Patented, proven design for superior reliability and durability, even in severe applications**
4. **Handles solids, solvents, hydrocarbons corrosive conditions, viscous fluids and high temperatures beyond the limits of electric pumps**
5. **Five-year warranty**



### Description

The AP4+ Bottom Inlet Short AutoPump provides maximum capabilities and flow in a bottom inlet pump for 4" (100 mm) diameter and larger wells with shorter water columns and/or the need to pump down to lower water levels, compared to full-length pumps. It is offered in optional versions to handle even the most severe remediation and landfill pumping applications, and delivers flow rates up to 13 gpm (49 lpm)\*. The AP4+ Short Bottom Inlet AutoPump is complemented by the most comprehensive selection of accessories to provide a complete system to meet site specific requirements. Call QED for prompt, no-obligation assistance on your pumping project needs.

### The AutoPump Heritage

The AP4+ Bottom Inlet Short AutoPump is part of the famous AutoPump family of original automatic air-powered pumps, developed in the mid 1980s specifically to handle unique pumping needs at remediation and landfill sites. Over the years they've proven their durability at thousands of sites worldwide. AutoPumps are designed to handle difficult pumping challenges that other pumps can't, such as hydrocarbons, solvents, suspended solids, corrosives, temperature extremes, viscous fluids and frequent start/stop cycles. Beyond just the pump, AutoPump systems offer the most complete range of tubing, hose, connectors, wellhead caps and accessories to help your installation go smoothly. This superior pumping heritage, application experience and support back up every AutoPump you put to work on your project.



# AP4+B

## Pump Dimensions

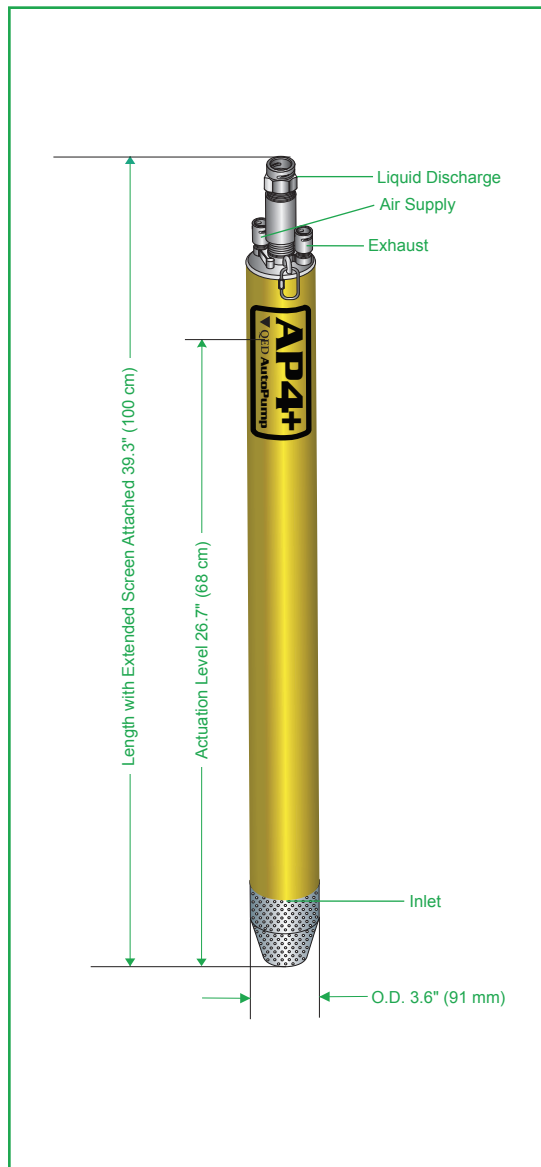

### Application Limits (Base model)

AP4+ AutoPumps are designed to handle the application ranges described below. For applications outside these ranges, consult QED about AP4+ upgrades.

**Maximum Temperature:** 180°F (82°C)

**pH Range:** 4-9

**Solvents and Fuels:** diesel, gasoline, JP1-JP6, #2 heating oils, BTEX, MTBE, landfill liquids

\*Consult QED for higher flow requirements

## Specifications & Operating Requirements

<b>Model</b>	<b>4" - Short AP4+ Bottom Inlet</b>
<b>Liquid Inlet Location</b>	Bottom
<b>O.D.</b>	3.6 in. (91 mm)
<b>Overall Length With Extended Screen</b>	39.3 in. (100 cm)
<b>Weight</b>	13.7 lbs. (6.2 kg)
<b>Maximum Flow Rate</b>	13 gpm (49 lpm)* - See Flow Rate Chart
<b>Pump Volume/Cycle</b>	0.22 - 0.36 gal (.83 - 1.36 L)
<b>Minimum Accuation Level</b>	26.7 in. (68 cm)
<b>Standard Pump</b>	
<b>Maximum Depth</b>	250 ft. (76 m)
<b>Air Pressure</b>	5 - 120 psi (0.4 - 8.4 kg/cm <sup>2</sup> )
<b>Air Usage</b>	0.4 - 1.1 scf / gal. (3.0 - 8.5 liter of air / fluid liter) - See air usage chart
<b>High Pressure Pump</b>	
<b>Maximum Depth</b>	425 ft. (130 m)
<b>Air Pressure</b>	5 - 200 psi (0.4 - 14.1 kg/cm <sup>2</sup> )
<b>Minimum Liquid Density</b>	0.7 SpG (0.7 g/cm <sup>3</sup> )
<b>Standard Construction Materials<sup>1</sup></b>	
<b>Pump Body</b>	Fiberglass or Stainless Steel
<b>Pump Ends</b>	Stainless Steel
<b>Internal Components</b>	Stainless Steel, Viton, PVDF, Hastelloy-C
<b>Tube &amp; Hose Fittings</b>	Brass or Stainless Steel
<b>Fitting Type</b>	Barbs, Quick Connects or Easy Fittings
<b>Tube &amp; Hose Options</b>	
<b>Tubing Materials<sup>2</sup></b>	Nylon
<b>Sizes - Liquid Discharge</b>	1 in. (25 mm) or 1-1/4 in. (32 mm) OD
<b>Pump Air Supply</b>	1/2 in. (13 mm) OD
<b>Air Exhaust</b>	5/8 in. (16 mm) OD
<b>Hose Material</b>	Nitrile
<b>Sizes - Liquid Discharge</b>	3/4 in. (19 mm) or 1 in. (25 mm) ID
<b>Pump Air Supply</b>	3/8 in. (9.5 mm) ID
<b>Air Exhaust</b>	1/2 in. (13 mm) ID

<sup>1</sup> Material upgrades available.  
<sup>2</sup> Applies to QED supplied tubing; other tubing sources may not conform to QED fittings.

Long and short AP4+ AutoPumps are warranted for five(5) years: Low-Drawdown AP4+ AutoPumps are warranted for one (1) year.

# AP4+B

## Flow Rates<sup>1</sup>

**3/4 inch (19 mm)  
Inside Diameter Discharge Hose  
(Equivalent to 1-Inch O.D. Tubing)**

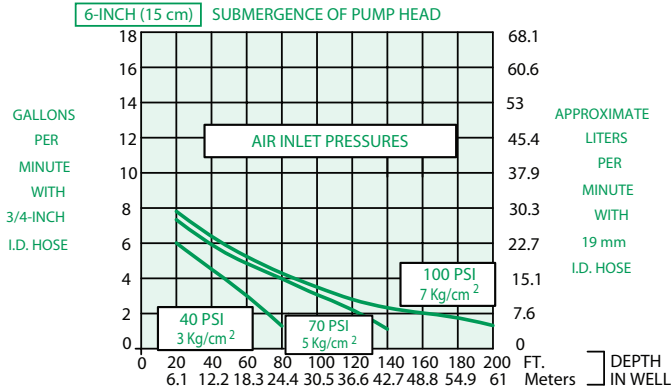

**1 inch (25.4 mm)  
Inside Diameter Discharge Hose  
(Equivalent to 1.25-Inch O.D. Tubing)**

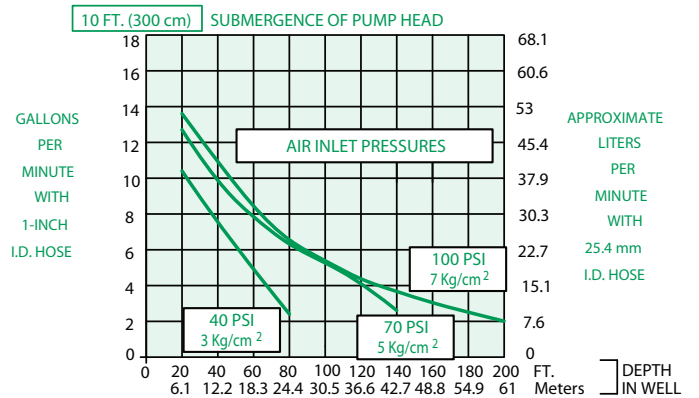
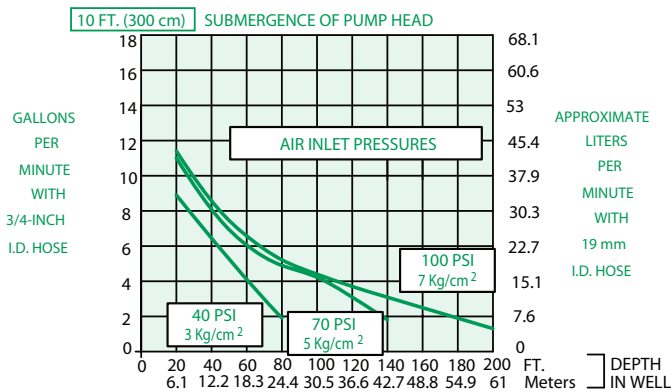
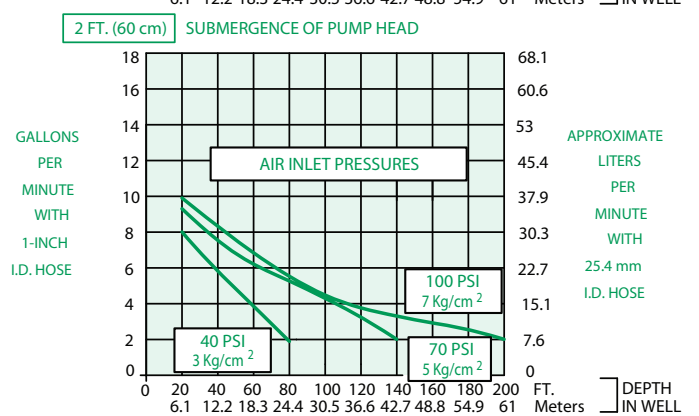
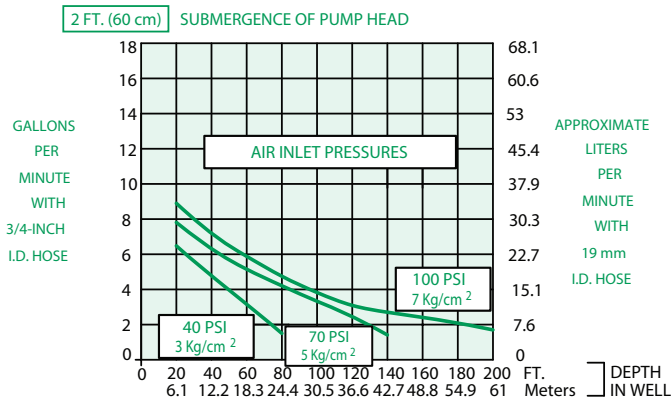
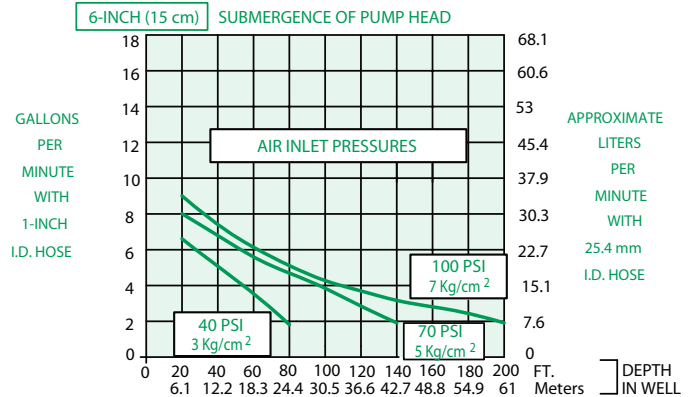

<sup>1</sup>FLOW RATES MAY VARY WITH SITE CONDITIONS. CALL QED FOR TECHNICAL ASSISTANCE.

# AP4+B

## Air Consumption



STANDARD  
CUBIC FEET OF AIR  
PER  
GALLON PUMPED  
(SCF/GAL)

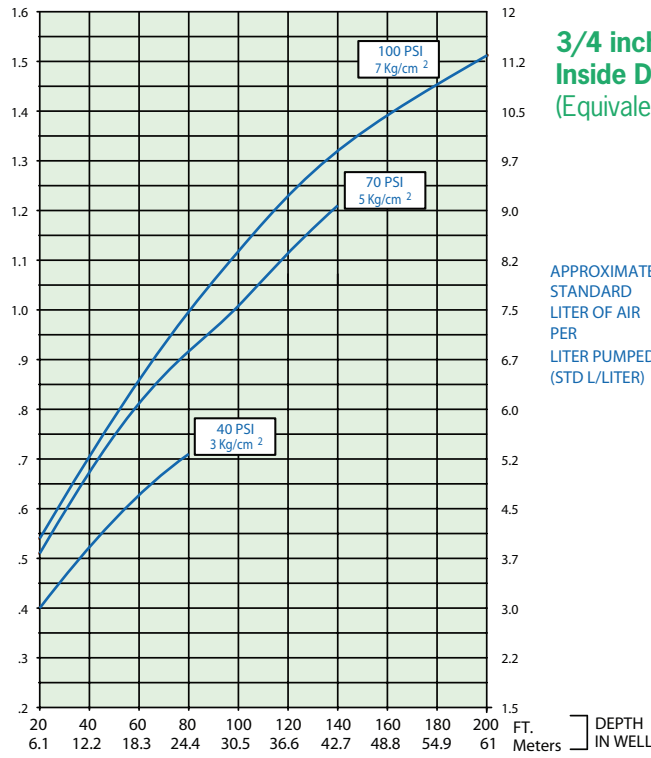

**3/4 inch (19 mm)**  
**Inside Diameter Discharge Hose**  
(Equivalent to 1-Inch O.D. Tubing)

APPROXIMATE  
STANDARD  
LITER OF AIR  
PER  
LITER PUMPED  
(STD L/LITER)

STANDARD  
CUBIC FEET OF AIR  
PER  
GALLON PUMPED  
(SCF/GAL)

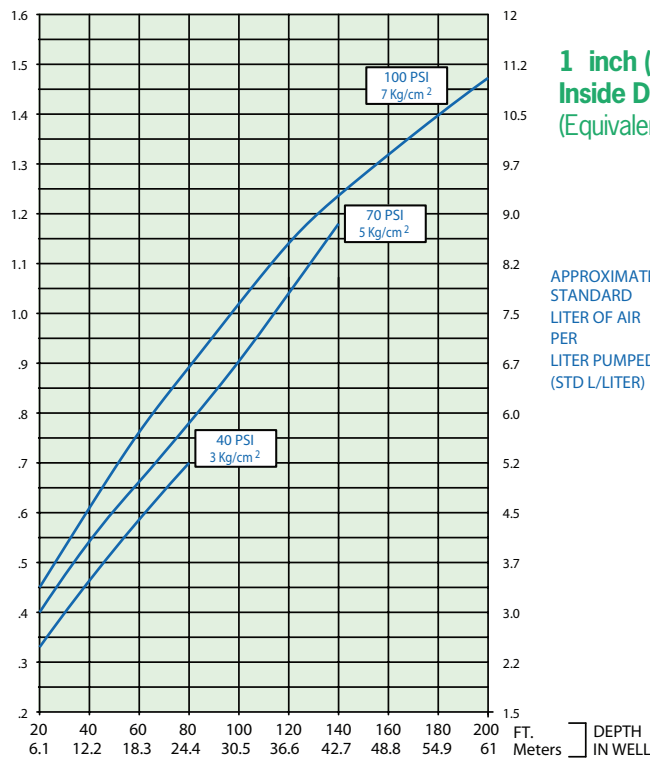

**1 inch (25.4 mm)**  
**Inside Diameter Discharge Hose**  
(Equivalent to 1.25-Inch O.D. Tubing)

APPROXIMATE  
STANDARD  
LITER OF AIR  
PER  
LITER PUMPED  
(STD L/LITER)

# LDAP4+B

**Max. Flow** 7.0 gpm (26.5 lpm)

**O.D.** 3.6 in (91 mm)

**Length** 27.5 in. (70 cm)

## Advantages

1. The original automatic air-powered well pump, proven worldwide over 23 years
2. The highest flow rates and deepest pumping capabilities in the industry in a low drawdown bottom-fill pump
3. Patented, proven design for superior reliability and durability, even in severe applications
4. Handles solids, solvents, hydrocarbons corrosive conditions, viscous fluids and high temperatures beyond the limits of electric pumps
5. One-year warranty



## Description

The AP4+ Low-Drawdown Bottom Inlet AutoPump provides maximum capabilities and flow in a bottom inlet pump for 4" (100 mm) diameter and larger wells with very short water columns and/or the need to pump down to as low as 15.3 inches (39 cm) above the bottom. It is offered in optional versions to handle even the most severe remediation and landfill pumping applications, and delivers flow rates up to 7 gpm (26.5 lpm). The AP4+ Low Drawdown Bottom Inlet AutoPump is complemented by the most comprehensive selection of accessories to provide a complete system to meet site specific requirements. Call QED for prompt, no-obligation assistance on your pumping project needs.

## The AutoPump Heritage

The AP4+ Low-Drawdown Bottom Inlet AutoPump is part of the famous AutoPump family of original automatic air-powered pumps, developed in the mid 1980s specifically to handle unique pumping needs at remediation and landfill sites. Over the years they've proven their durability at thousands of sites worldwide. AutoPumps are designed to handle difficult pumping challenges that other pumps can't, such as hydrocarbons, solvents, suspended solids, corrosives, temperature extremes, viscous fluids and frequent start/stop cycles. Beyond just the pump, AutoPump systems offer the most complete range of tubing, hose, connectors, wellhead caps and accessories to help your installation go smoothly. This superior pumping heritage, application experience and support back up every AutoPump you put to work on your project.

# LDAP4+B

## Pump Dimensions

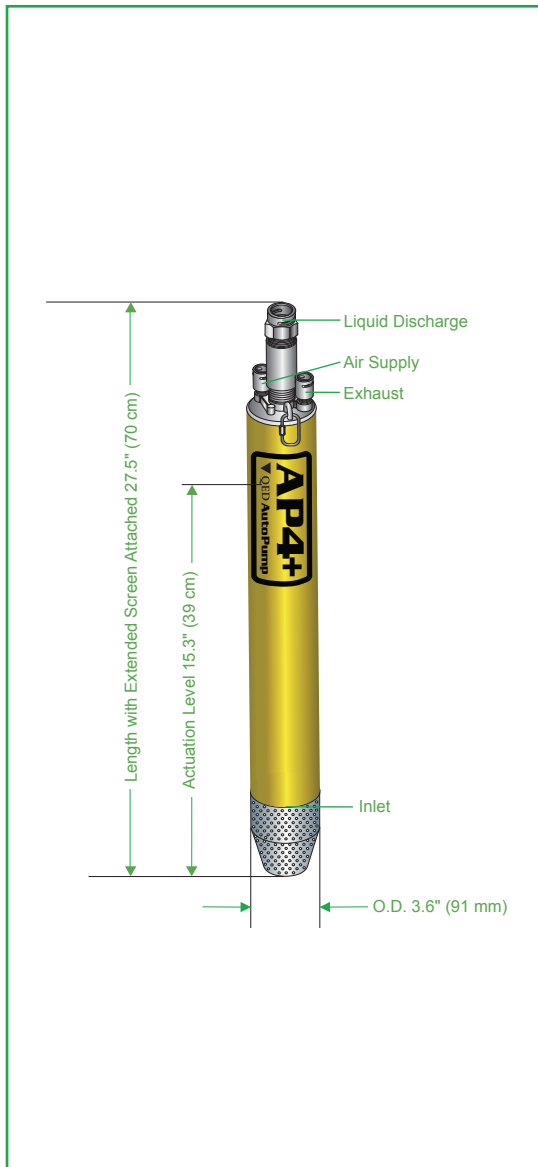

## Specifications & Operating Requirements

<b>Model</b>	<b>4" - Low Drawdown AP4+ Bottom Inlet</b>
<b>Liquid Inlet Location</b>	Bottom
<b>O.D.</b>	3.6 in. (91 mm)
<b>Overall Length With Extended Screen</b>	27.5 in. (70 cm)
<b>Weight</b>	11.7 lbs. (5.3 kg)
<b>Maximum Flow Rate</b>	7 gpm (26.5 lpm)* - See Flow Rate Chart
<b>Pump Volume/Cycle</b>	0.11 - 0.16 gal (.42 - .61 L)
<b>Minimum Accuation Level</b>	15.3 in. (39 cm)
<b>Maximum Depth</b>	250 ft. (76 m)
<b>Air Pressure</b>	5 - 120 psi (0.4 - 8.4 kg/cm <sup>2</sup> )
<b>Air Usage</b>	.32 - 2.86 scf/gal. (2.2 - 21.5 liter of air / fluid liter) - See air usage chart
<b>Minimum Liquid Density</b>	0.7 SpG (0.7 g/cm <sup>3</sup> )
<b>Standard Construction Materials<sup>1</sup></b>	
<b>Pump Body</b>	Fiberglass or Stainless Steel
<b>Pump Ends</b>	Stainless Steel
<b>Internal Components</b>	Stainless Steel, Viton, PVDF, Hastelloy-C
<b>Tube &amp; Hose Fittings</b>	Brass or Stainless Steel
<b>Fitting Type</b>	Barbs, Quick Connects or Easy Fittings
<b>Tube &amp; Hose Options</b>	
<b>Tubing Materials<sup>2</sup></b>	Nylon
<b>Sizes - Liquid Discharge</b>	1 in. (25 mm) or 1-1/4 in. (32 mm) OD
<b>Pump Air Supply</b>	1/2 in. (13 mm) OD
<b>Air Exhaust</b>	5/8 in. (16 mm) OD
<b>Hose Material</b>	Nitrile
<b>Sizes - Liquid Discharge</b>	3/4 in. (19 mm) or 1 in. (25 mm) ID
<b>Pump Air Supply</b>	3/8 in. (9.5 mm) ID
<b>Air Exhaust</b>	1/2 in. (13 mm) ID

<sup>1</sup> Material upgrades available

<sup>2</sup> Applies to QED supplied tubing; other tubing sources may not conform to QED fittings.

Low-Drawdown AP4+ AutoPumps are warranted for one (1) year.

## Application Limits (Base model)

AP4+ AutoPumps are designed to handle the application ranges described below. For applications outside these ranges, consult QED about AP4+ upgrades.

**Maximum Temperature:** 180°F (82°C)

**pH Range:** 4-9

**Solvents and Fuels:** diesel, gasoline, JP1-JP6, #2 heating oils, BTEX, MTBE, landfill liquids

\*Consult QED for higher flow requirements

# LDAP4+B

## Flow Rates<sup>1</sup>

**3/4 inch (19 mm)  
Inside Diameter Discharge Hose  
(Equivalent to 1-Inch O.D. Tubing)**

**1 inch (25.4 mm)  
Inside Diameter Discharge Hose  
(Equivalent to 1.25-Inch O.D. Tubing)**

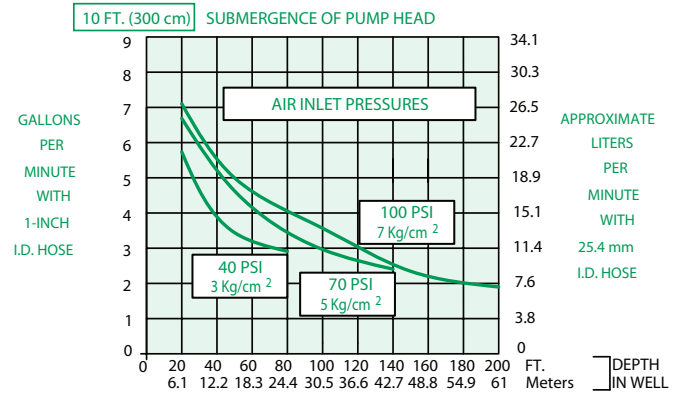
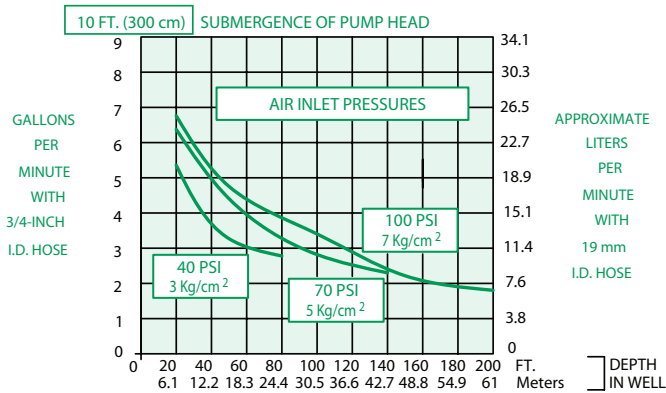
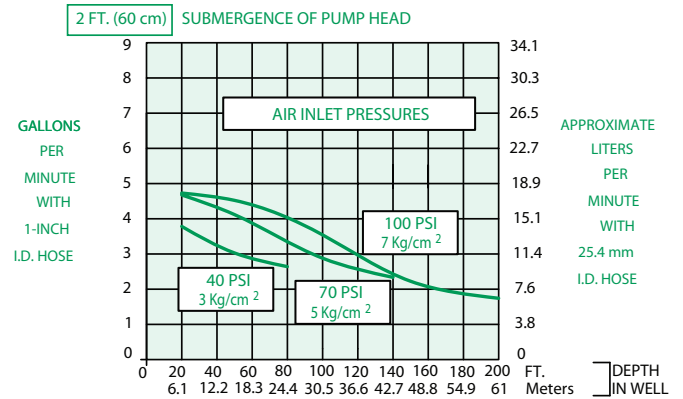
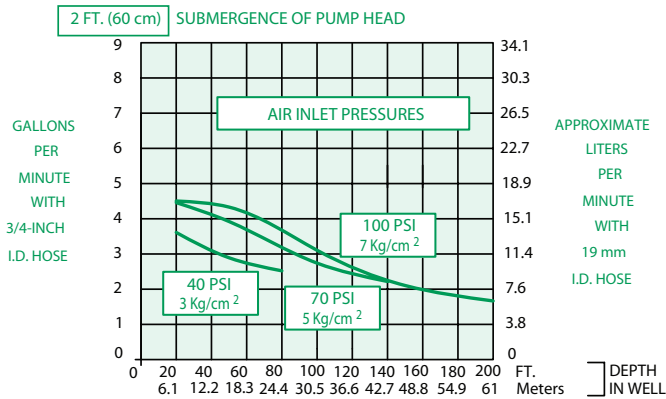
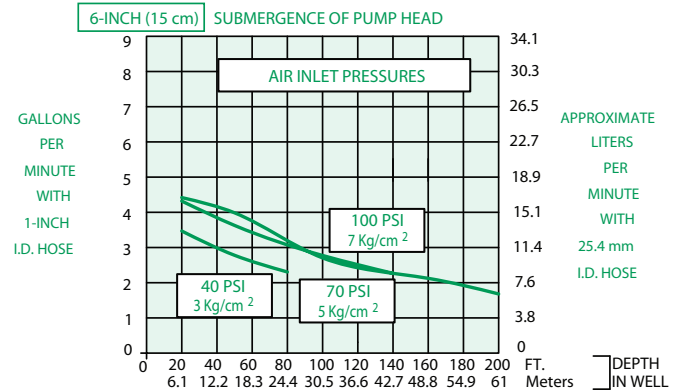
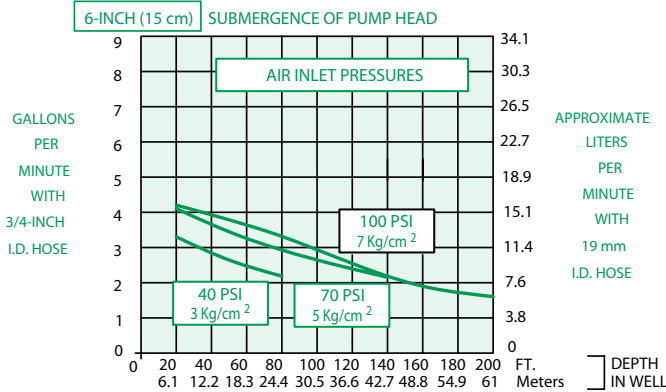

<sup>1</sup>FLOW RATES MAY VARY WITH SITE CONDITIONS. CALL QED FOR TECHNICAL ASSISTANCE.

# LDAP4+B



STANDARD  
CUBIC FEET OF AIR  
PER  
GALLON PUMPED  
(SCF/GAL)

## Air Consumption

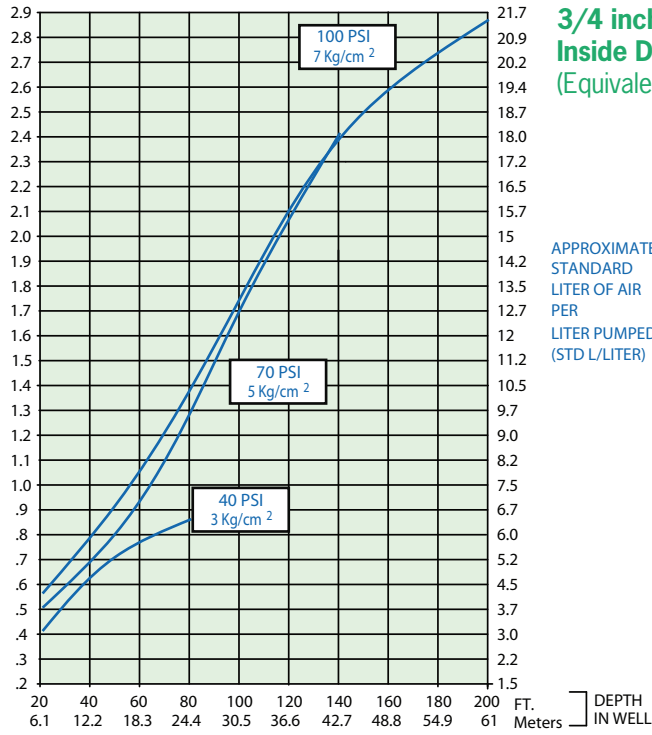

**3/4 inch (19 mm)**  
**Inside Diameter Discharge Hose**  
(Equivalent to 1-Inch O.D. Tubing)

APPROXIMATE  
STANDARD  
LITER OF AIR  
PER  
LITER PUMPED  
(STD L/LITER)

STANDARD  
CUBIC FEET OF AIR  
PER  
GALLON PUMPED  
(SCF/GAL)

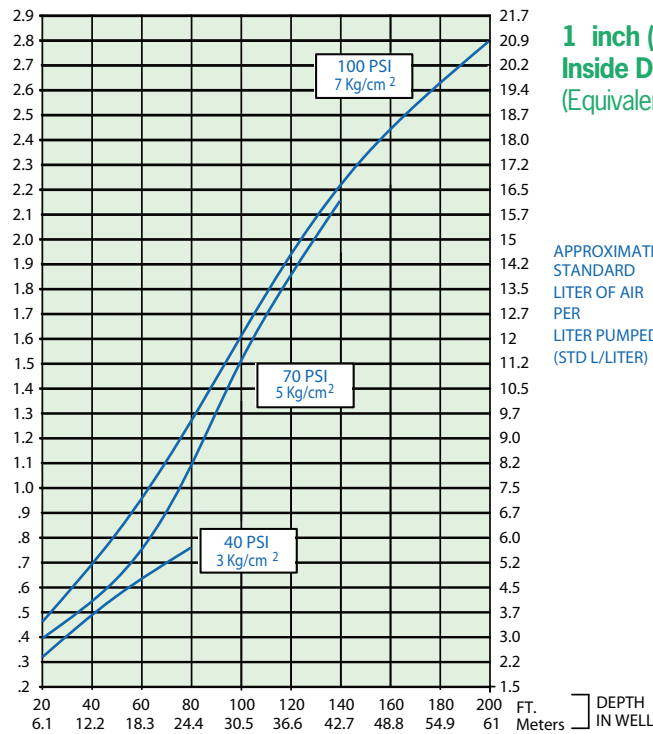

**1 inch (25.4 mm)**  
**Inside Diameter Discharge Hose**  
(Equivalent to 1.25-Inch O.D. Tubing)

APPROXIMATE  
STANDARD  
LITER OF AIR  
PER  
LITER PUMPED  
(STD L/LITER)

# AP4+T

**Max. Flow** 10 gpm (38 lpm)

**O.D.** 3.6 in (91 mm)

**Length** 56.7 in. (144 cm)

## Advantages

1. The original automatic air-powered well pump, proven worldwide over 23 years
2. The highest flow rates and deepest pumping capabilities in the industry
3. Patented, proven design for superior reliability and durability, even in severe applications
4. Handles solids, solvents, hydrocarbons corrosive conditions, viscous fluids and high temperatures beyond the limits of electric pumps
5. Five-year warranty



## Description

The AP4+ Top Inlet Long AutoPump provides maximum capabilities and flow in a top inlet pump for 4" diameter and larger wells needing an elevated inlet, such as pumping total fluids from wells contaminated with LNAPLs. It is offered in optional versions to handle even the most severe remediation and landfill pumping applications, and delivers flow rates up to 10 gpm\*. The AP4+ Long Top Inlet AutoPump is complemented by the most comprehensive selection of accessories to provide a complete system to meet site specific requirements. Call QED for prompt, no-obligation assistance on your pumping project needs.

## The AutoPump Heritage

The AP4+ Top Inlet Long AutoPump is part of the famous AutoPump family of original automatic air-powered pumps, developed in the mid 1980s specifically to handle unique pumping needs at remediation and landfill sites. Over the years they've proven their durability at thousands of sites worldwide. AutoPumps are designed to handle difficult pumping challenges that other pumps can't, such as hydrocarbons, solvents, suspended solids, corrosives, temperature extremes, viscous fluids and frequent start/stop cycles. Beyond just the pump, AutoPump systems offer the most complete range of tubing, hose, connectors, wellhead caps and accessories to help your installation go smoothly. This superior pumping heritage, application experience and support back up every AutoPump you put to work on your project.



# AP4+T

## Pump Dimensions

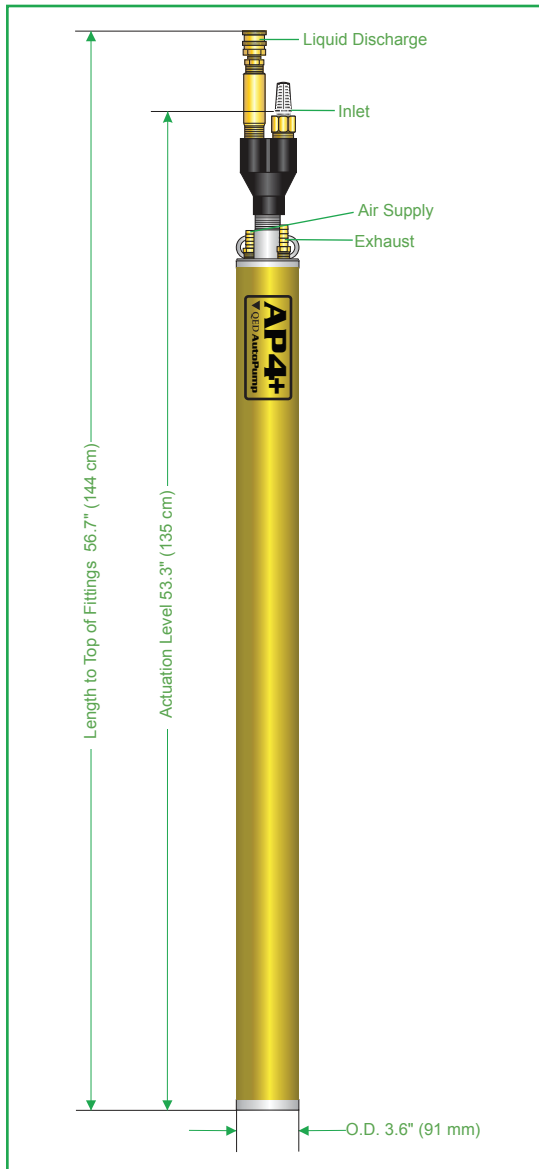

## Application Limits (Base model)

AP4+ AutoPumps are designed to handle the application ranges described below. For applications outside these ranges, consult QED about AP4+ upgrades.

**Maximum Temperature:** 180°F (82°C)

**pH Range:** 4-9

**Solvents and Fuels:** diesel, gasoline, JP1-JP6, #2 heating oils, BTEX, MTBE, landfill liquids

**\*Consult QED for higher flow requirements**

## Specifications & Operating Requirements

<b>Model</b>	<b>4" - Long AP4+ Top Inlet</b>
<b>Liquid Inlet Location</b>	Top
<b>O.D.</b>	3.6 in. (91 mm)
<b>Overall Length (Pump &amp; Fittings)</b>	56.7 in. (144 cm)
<b>Weight</b>	16.5 lbs. (7.6 kg)
<b>Maximum Flow Rate</b>	10 gpm (38 lpm)* - See Flow Rate Chart
<b>Pump Volume/Cycle</b>	0.58 - 0.78 gal (2.2 - 3L)
<b>Minimum Accuation Level</b>	53.3 in. (135 cm)
<b>Standard Pump</b>	
<b>Maximum Depth</b>	250 ft. (76 m)
<b>Air Pressure</b>	5 - 120 psi (0.4 - 8.4 kg/cm <sup>2</sup> )
<b>Air Usage</b>	0.35 - 1.1 scf / gal. (3.0 - 8.4 liter of air / fluid liter) - See air usage chart
<b>High Pressure Pump</b>	
<b>Maximum Depth</b>	425 ft. (130 m)
<b>Air Pressure</b>	5 - 200 psi (0.4 - 14.1 kg/cm <sup>2</sup> )
<b>Minimum Liquid Density</b>	0.7 SpG (0.7 g/cm <sup>3</sup> )
<b>Standard Construction Materials<sup>1</sup></b>	
<b>Pump Body</b>	Fiberglass or Stainless Steel
<b>Pump Ends</b>	Stainless Steel
<b>Internal Components</b>	Stainless Steel, Viton, PVDF, Hastelloy-C
<b>Tube &amp; Hose Fittings</b>	Brass or Stainless Steel
<b>Fitting Type</b>	Barbs, Quick Connects or Easy Fittings
<b>Tube &amp; Hose Options</b>	
<b>Tubing Materials<sup>1</sup></b>	Nylon
<b>Sizes - Liquid Discharge</b>	1 in. (25 mm) or 1-1/4 in. (32 mm) OD
<b>Pump Air Supply</b>	1/2 in. (13 mm) OD
<b>Air Exhaust</b>	5/8 in. (16 mm) OD
<b>Hose Material</b>	Nitrile
<b>Sizes - Liquid Discharge</b>	3/4 in. (19 mm) or 1 in. (25 mm) ID
<b>Pump Air Supply</b>	3/8 in. (9.5 mm) ID
<b>Air Exhaust</b>	1/2 in. (13 mm) ID

<sup>1</sup> Applies to QED supplied tubing; other tubing sources may not conform to QED fittings.

Long and short AP4+ AutoPumps are warranted for five(5) years: Low-Drawdown AP4+ AutoPumps are warranted for one (1) year.

# AP4+T

## Flow Rates<sup>1</sup>

**3/4 inch (19 mm)  
Inside Diameter Discharge Hose**  
(Equivalent to 1-Inch O.D. Tubing)

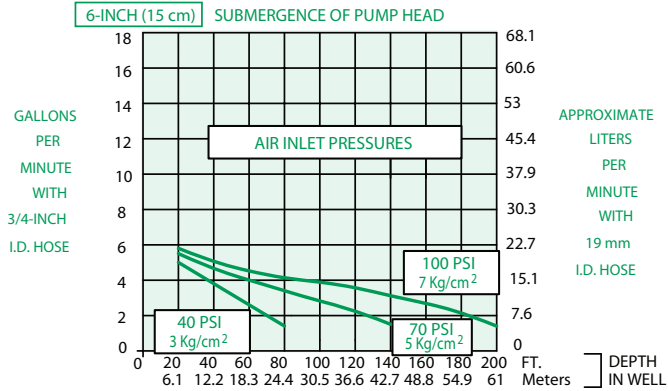

**1 inch (25.4 mm)  
Inside Diameter Discharge Hose**  
(Equivalent to 1.25-Inch O.D. Tubing)

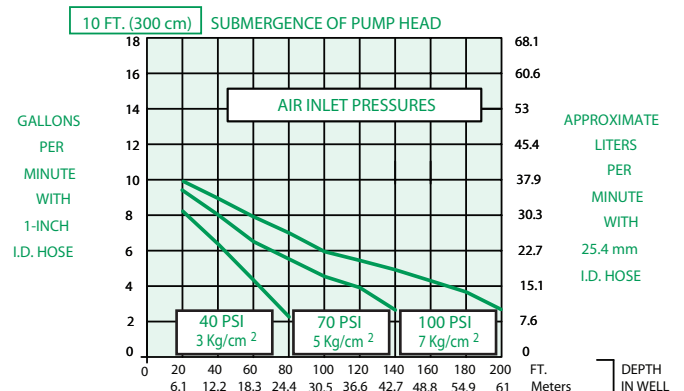
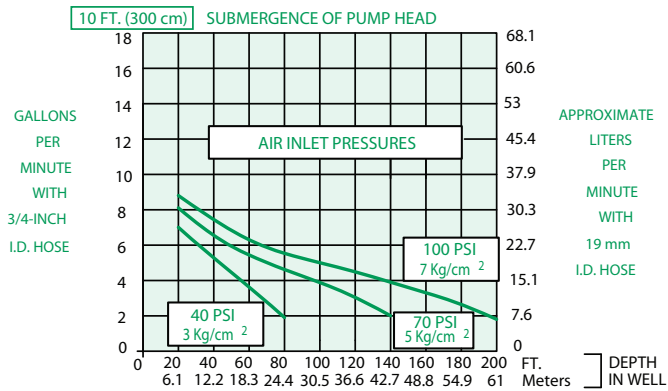
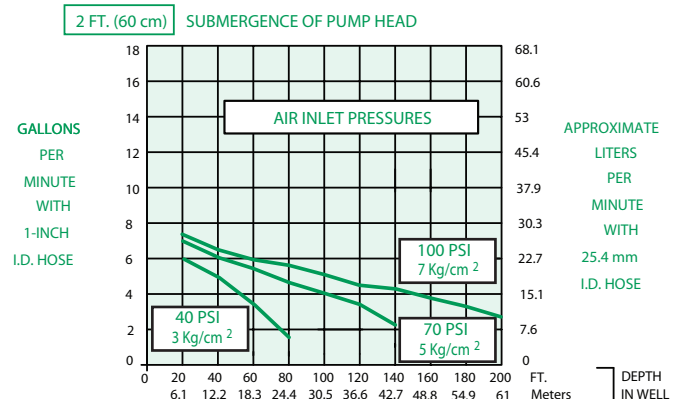
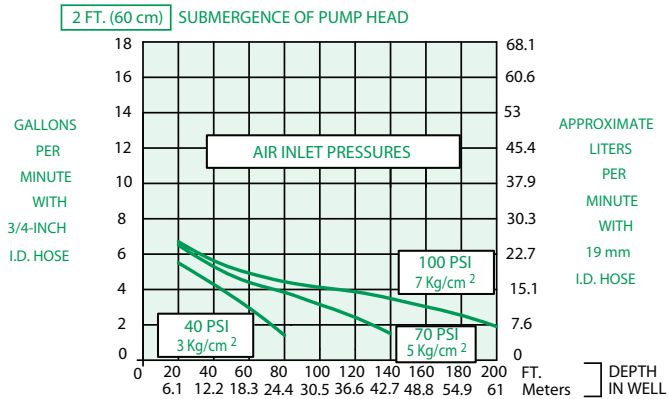
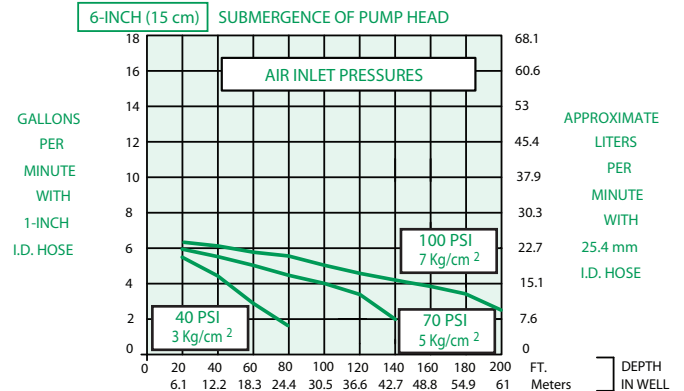

<sup>1</sup>FLOW RATES MAY VARY WITH SITE CONDITIONS. CALL QED FOR TECHNICAL ASSISTANCE.

# AP4+T



STANDARD  
CUBIC FEET OF AIR  
PER  
GALLON PUMPED  
(SCF/GAL)

STANDARD  
CUBIC FEET OF AIR  
PER  
GALLON PUMPED  
(SCF/GAL)

## Air Consumption

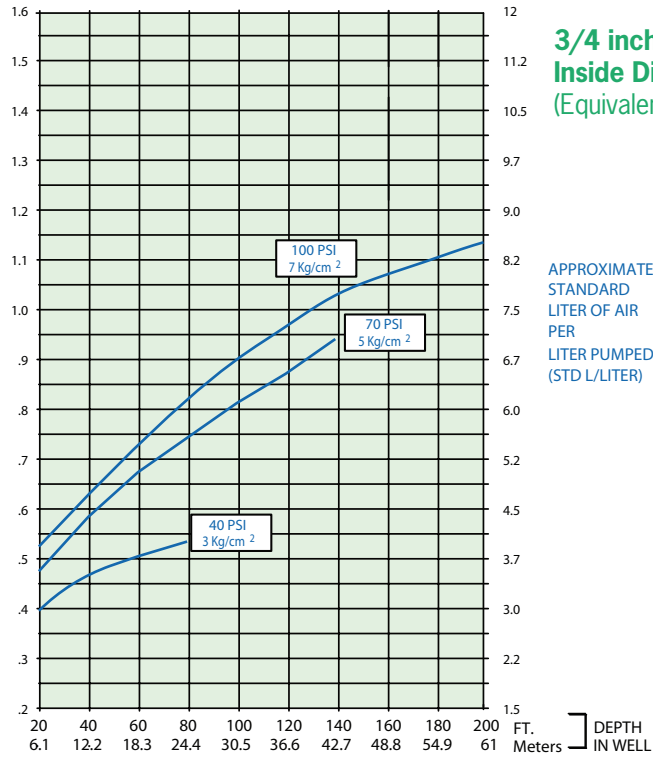

**3/4 inch (19 mm)**  
**Inside Diameter Discharge Hose**  
(Equivalent to 1-Inch O.D. Tubing)

APPROXIMATE  
STANDARD  
LITER OF AIR  
PER  
LITER PUMPED  
(STD L/LITER)

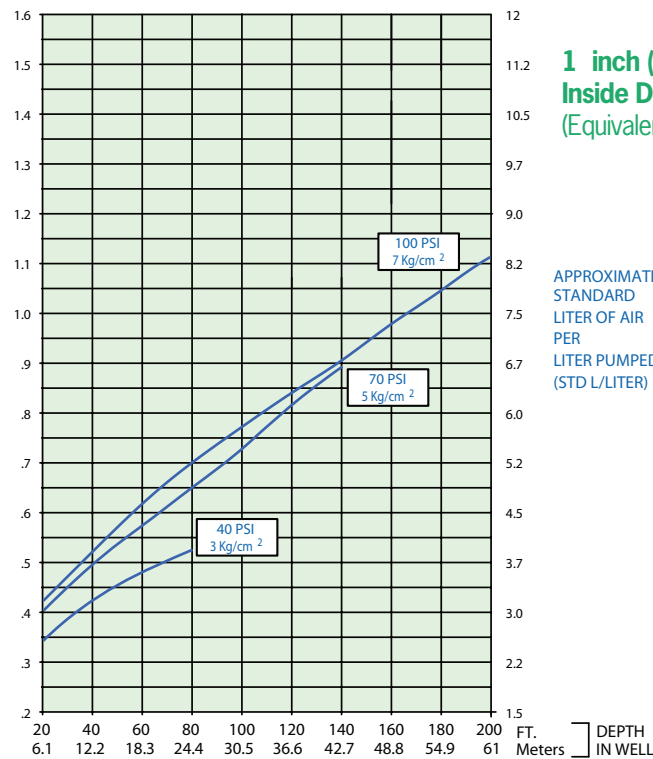

**1 inch (25.4 mm)**  
**Inside Diameter Discharge Hose**  
(Equivalent to 1.25-Inch O.D. Tubing)

APPROXIMATE  
STANDARD  
LITER OF AIR  
PER  
LITER PUMPED  
(STD L/LITER)

# AP4+T

**Max. Flow** 9 gpm (34 lpm)

**O.D.** 3.6 in (91 mm)

**Length** 45 in. (110 cm)



## Description

The AP4+ Top Inlet Short AutoPump provides maximum capabilities and flow in a top inlet pump for 4" (100 mm) diameter and larger wells with shorter water columns and the need for an elevated inlet, such as pumping total fluids from wells contaminated with LNAPLs. It is offered in optional versions to handle even the most severe remediation and landfill pumping applications, and delivers flow rates up to 9 gpm (34 lpm)\*. The AP4+ Short Top Inlet AutoPump is complemented by the most comprehensive selection of accessories to provide a complete system to meet site specific requirements. Call QED for prompt, no-obligation assistance on your pumping project needs.

## The AutoPump Heritage

The AP4+ Top Inlet Short AutoPump is part of the famous AutoPump family of original automatic air-powered pumps, developed in the mid 1980s specifically to handle unique pumping needs at remediation and landfill sites. Over the years they've proven their durability at thousands of sites worldwide. AutoPumps are designed to handle difficult pumping challenges that other pumps can't, such as hydrocarbons, solvents, suspended solids, corrosives, temperature extremes, viscous fluids and frequent start/stop cycles. Beyond just the pump, AutoPump systems offer the most complete range of tubing, hose, connectors, wellhead caps and accessories to help your installation go smoothly. This superior pumping heritage, application experience and support back up every AutoPump you put to work on your project.

## Advantages

1. **The original automatic air-powered well pump, proven worldwide over 23 years**
2. **The highest flow rates and deepest pumping capabilities in the industry**
3. **Patented, proven design for superior reliability and durability, even in severe applications**
4. **Handles solids, solvents, hydrocarbons corrosive conditions, viscous fluids and high temperatures beyond the limits of electric pumps**
5. **Five-year warranty**

# AP4+T

## Pump Dimensions

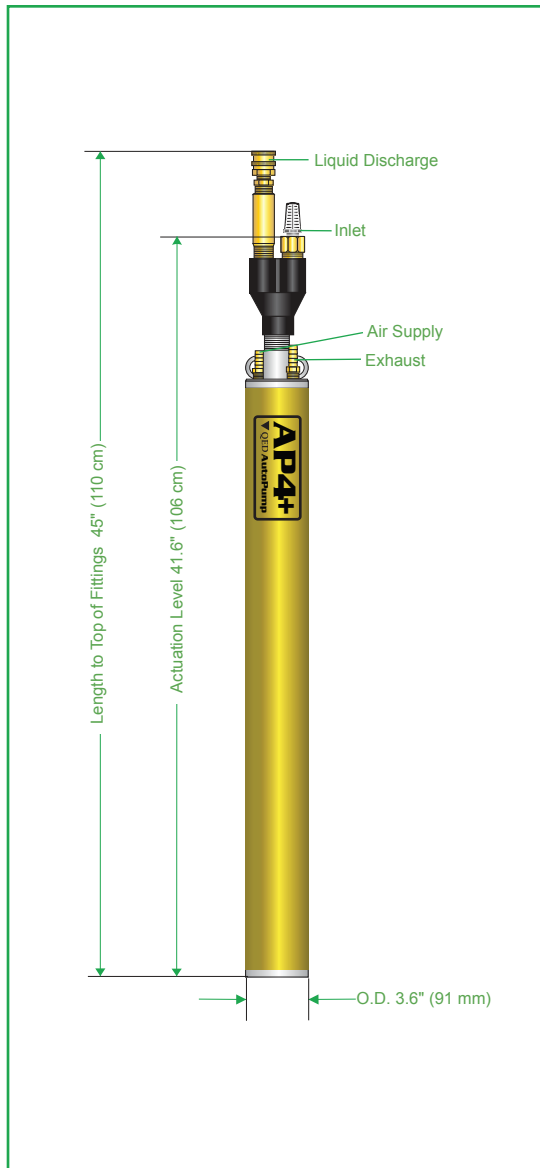

## Application Limits (Base model)

AP4+ AutoPumps are designed to handle the application ranges described below. For applications outside these ranges, consult QED about AP4+ upgrades.

**Maximum Temperature:** 180°F (82°C)

**pH Range:** 4-9

**Solvents and Fuels:** diesel, gasoline, JP1-JP6, #2 heating oils, BTEX, MTBE, landfill liquids

\*Consult QED for higher flow requirements

## Specifications & Operating Requirements

<b>Model</b>	<b>4" - Short AP4+ Top Inlet</b>
<b>Liquid Inlet Location</b>	Top
<b>O.D.</b>	3.6 in. (91 mm)
<b>Overall Length (Pump &amp; Fittings)</b>	45 in. (110 cm)
<b>Weight</b>	15.8 lbs. (7.2 kg)
<b>Maximum Flow Rate</b>	9 gpm (34 lpm)* - See Flow Rate Chart
<b>Pump Volume/Cycle</b>	0.22 - 0.36 gal (.83 - 1.36 L)
<b>Minimum Accuation Level</b>	41.6 in. (106 cm)
<b>Standard Pump</b>	
<b>Maximum Depth</b>	250 ft. (76 m)
<b>Air Pressure</b>	5 - 120 psi (0.4 - 8.4 kg/cm <sup>2</sup> )
<b>Air Usage</b>	0.35 - 1.5 scf / gal. (2.4 - 8.4 liter of air / fluid liter) - See air usage chart
<b>High Pressure Pump</b>	
<b>Maximum Depth</b>	425 ft. (130 m)
<b>Air Pressure</b>	5 - 200 psi (0.4 - 14.1 kg/cm <sup>2</sup> )
<b>Minimum Liquid Density</b>	0.7 SpG (0.7 g/cm <sup>3</sup> )
<b>Standard Construction Materials</b>	
<b>Pump Body</b>	Fiberglass or Stainless Steel
<b>Pump Ends</b>	Stainless Steel
<b>Internal Components</b>	Stainless Steel, Viton, PVDF, Hastelloy-C
<b>Tube &amp; Hose Fittings</b>	Brass or Stainless Steel
<b>Fitting Type</b>	Barbs, Quick Connects or Easy Fittings
<b>Tube &amp; Hose Options</b>	
<b>Tubing Materials<sup>1</sup></b>	Nylon
<b>Sizes - Liquid Discharge</b>	1 in. (25 mm) or 1-1/4 in. (32 mm) OD
<b>Pump Air Supply</b>	1/2 in. (13 mm) OD
<b>Air Exhaust</b>	5/8 in. (16 mm) OD
<b>Hose Material</b>	Nitrile
<b>Sizes - Liquid Discharge</b>	3/4 in. (19 mm) or 1 in. (25 mm) ID
<b>Pump Air Supply</b>	3/8 in. (9.5 mm) ID
<b>Air Exhaust</b>	1/2 in. (13 mm) ID

<sup>1</sup> Applies to QED supplied tubing; other tubing sources may not conform to QED fittings.

Long and short AP4+ AutoPumps are warranted for five(5) years: Low-Drawdown AP4+ AutoPumps are warranted for one (1) year.

# AP4+T

## Flow Rates<sup>1</sup>

**3/4 inch (19 mm)  
Inside Diameter Discharge Hose  
(Equivalent to 1-Inch O.D. Tubing)**

**1 inch (25.4 mm)  
Inside Diameter Discharge Hose  
(Equivalent to 1.25-Inch O.D. Tubing)**

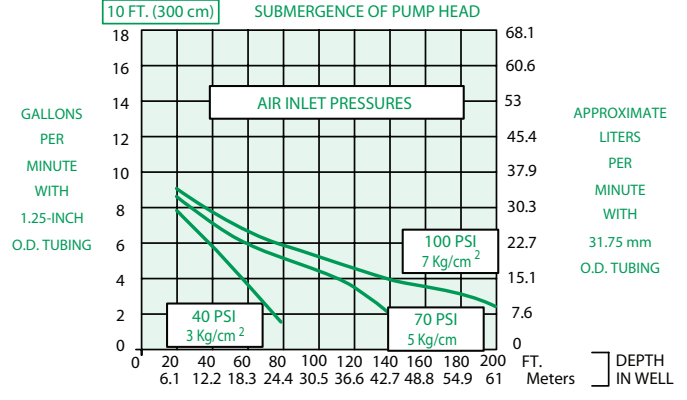
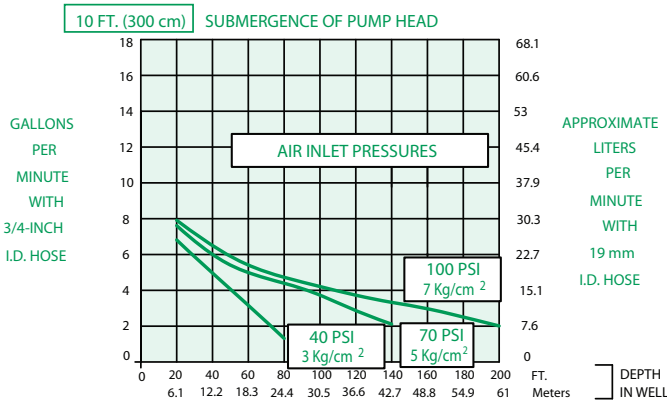
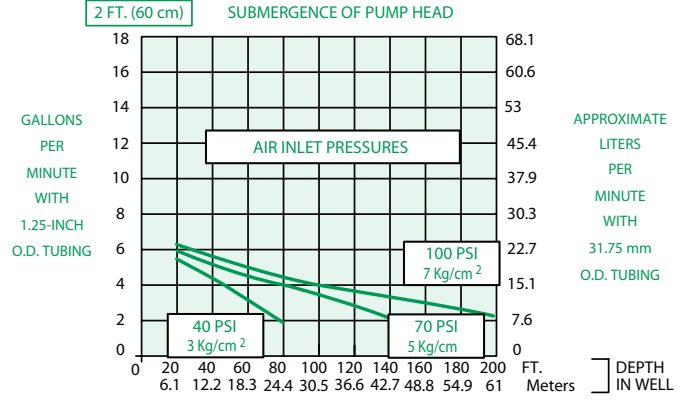
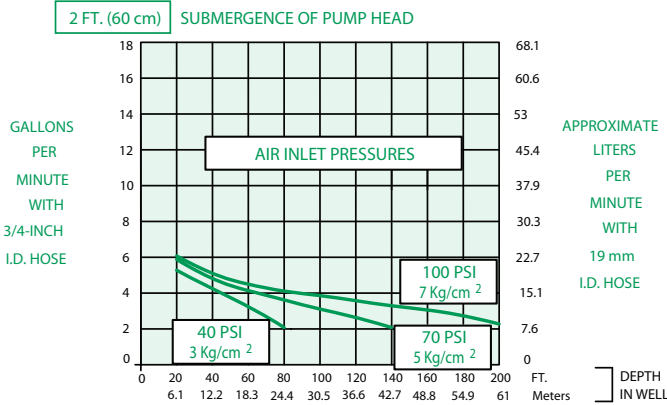
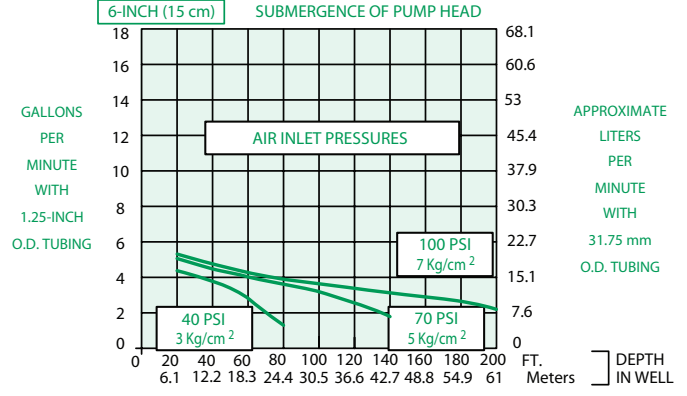
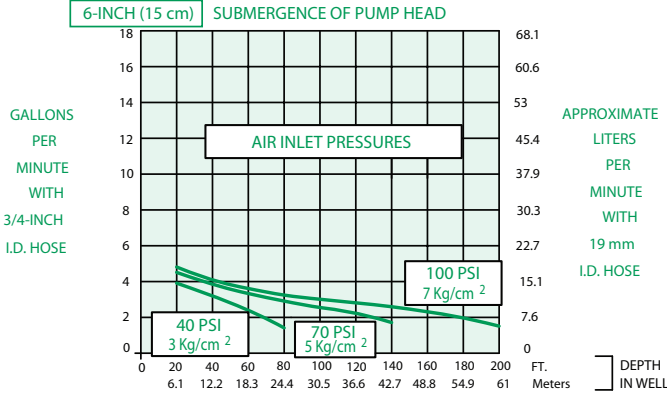

<sup>1</sup>FLOW RATES MAY VARY WITH SITE CONDITIONS. CALL QED FOR TECHNICAL ASSISTANCE.

# AP4+T

## Air Consumption



STANDARD  
CUBIC FEET OF AIR  
PER  
GALLON PUMPED  
(SCF/GAL)

STANDARD  
CUBIC FEET OF AIR  
PER  
GALLON PUMPED  
(SCF/GAL)

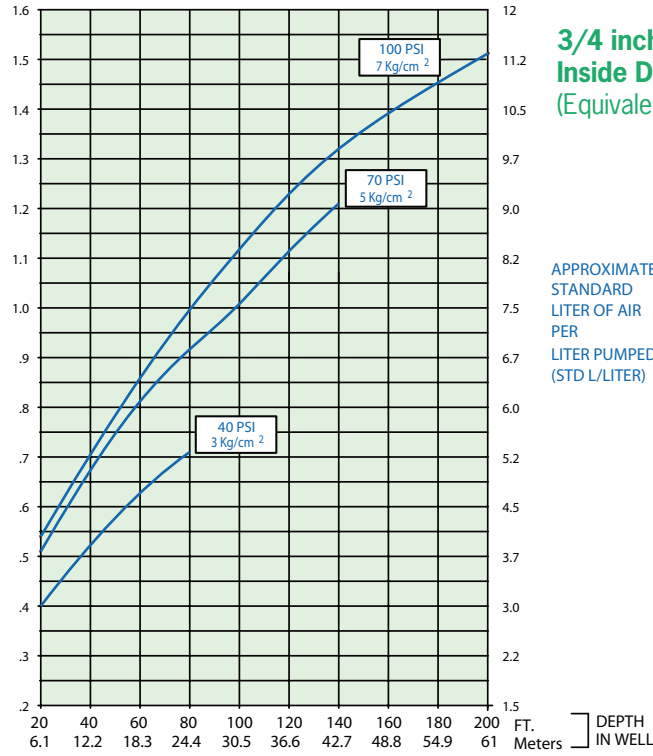

**3/4 inch (19 mm)**  
**Inside Diameter Discharge Hose**  
(Equivalent to 1-Inch O.D. Tubing)

APPROXIMATE  
STANDARD  
LITER OF AIR  
PER  
LITER PUMPED  
(STD L/LITER)

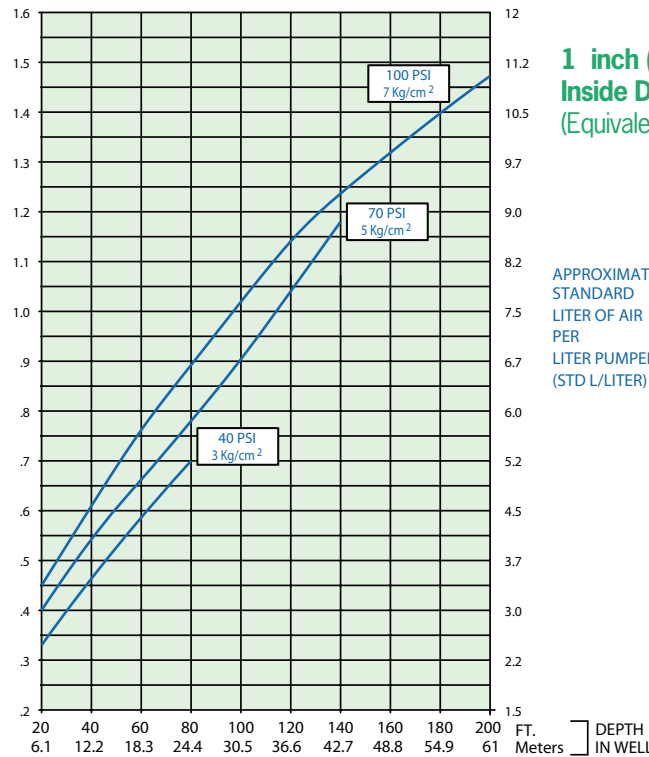

**1 inch (25.4 mm)**  
**Inside Diameter Discharge Hose**  
(Equivalent to 1.25-Inch O.D. Tubing)

APPROXIMATE  
STANDARD  
LITER OF AIR  
PER  
LITER PUMPED  
(STD L/LITER)

# LDAP4+T

**Max. Flow** 6.4 gpm (24 lpm)

**O.D.** 3.6 in (91 mm)

**Length** 30.75 in. (78 cm)



## Description

The Low-Drawdown AP4+ Top Inlet AutoPump provides maximum capabilities and flow in a top inlet pump for 4" (100 mm) diameter and larger wells with very short water columns and/or the need to pump down to as low as 27.4 inches (70 cm) above the bottom. It is offered in optional versions to handle even the most severe remediation and landfill pumping applications, and delivers flow rates up to 6.4 gpm (24 lpm). The Low Drawdown AP4+ Top Inlet AutoPump is complemented by the most comprehensive selection of accessories to provide a complete system to meet site specific requirements. Call QED for prompt, no-obligation assistance on your pumping project needs.

## The AutoPump Heritage

The Low-Drawdown AP4+ Top Inlet AutoPump is part of the famous AutoPump family of original automatic air-powered pumps, developed in the mid 1980s specifically to handle unique pumping needs at remediation and landfill sites. Over the years they've proven their durability at thousands of sites worldwide. AutoPumps are designed to handle difficult pumping challenges that other pumps can't, such as solvents, suspended solids, corrosives, temperature extremes, viscous fluids and frequent start/stop cycles. Beyond just the pump, AutoPump systems offer the most complete range of tubing, hose, connectors, caps and accessories to help your installation go smoothly. This superior pumping heritage, application experience and support back up every AutoPump you put to work on your project.

## Advantages

1. **The original automatic air-powered well pump, proven worldwide over 23 years**
2. **The highest flow rates and deepest pumping capabilities in the industry in a low drawdown top-fill pump**
3. **Patented, proven design for superior reliability and durability, even in severe applications**
4. **Handles solids, solvents, corrosive conditions, viscous fluids and high temperatures beyond the limits of electric pumps**
5. **One-year warranty**



# LDAP4+T

## Pump Dimensions

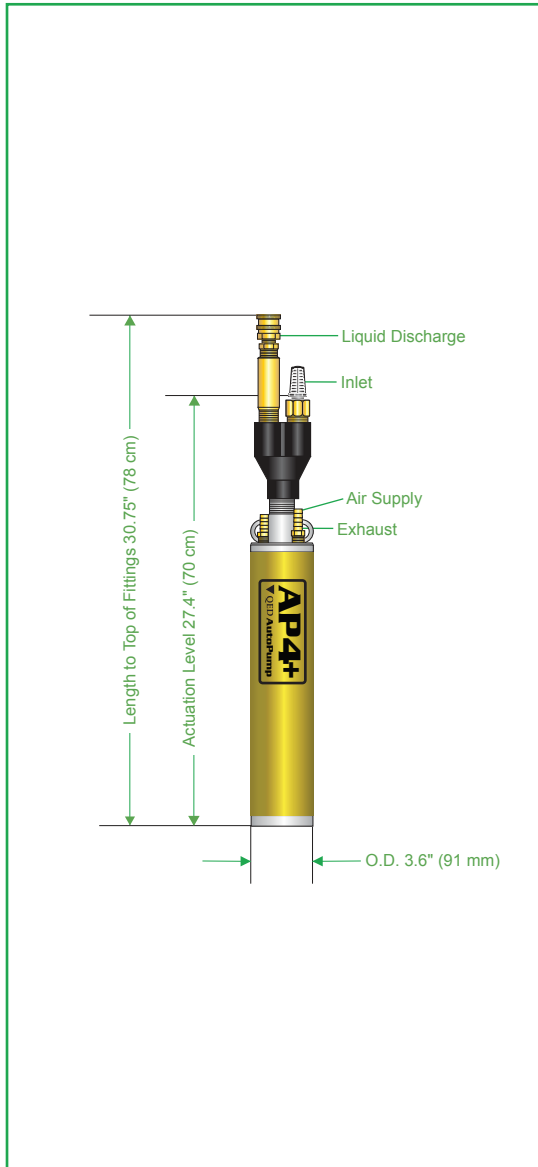

## Specifications & Operating Requirements

<b>Model</b>	<b>4" - Low Drawdown AP4+ Top Inlet</b>
<b>Liquid Inlet Location</b>	Top
<b>O.D.</b>	3.6 in. (91 mm)
<b>Overall Length (Pumps &amp; Fittings)</b>	30.75 in. (78 cm)
<b>Weight</b>	9.8 lbs. (4.4 kg)
<b>Maximum Flow Rate</b>	6.4 gpm (24 lpm)
<b>Pump Volume/Cycle</b>	0.11 - 0.16 gal (.42 - .61 L)
<b>Minimum Accuation Level</b>	27.4 in. (70 cm)
<b>Maximum Depth</b>	250 ft. (76 m)
<b>Air Pressure</b>	5 - 120 psi (0.4 - 8.4 kg/cm2)
<b>Air Usage</b>	.31 - 2.85 scf/gal. (2.2 - 21.5 liter of air / fluid liter) - See air usage chart
<b>Minimum Liquid Density</b>	0.7 SpG (0.7 g/cm3)
<b>Standard Construction Materials<sup>1</sup></b>	
<b>Pump Body</b>	Fiberglass or Stainless Steel
<b>Pump Ends</b>	Stainless Steel
<b>Internal Components</b>	Stainless Steel, Viton, PVDF, Hastelloy-C
<b>Tube &amp; Hose Fittings</b>	Brass or Stainless Steel
<b>Fitting Type</b>	Barbs, Quick Connects or Easy Fittings
<b>Tube &amp; Hose Options</b>	
<b>Tubing Materials<sup>1</sup></b>	Nylon
<b>Sizes - Liquid Discharge</b>	1 in. (25 mm) or 1-1/4 in. (32 mm) OD
<b>Pump Air Supply</b>	1/2 in. (13 mm) OD
<b>Air Exhaust</b>	5/8 in. (16 mm) OD
<b>Hose Material</b>	Nitrile
<b>Sizes - Liquid Discharge</b>	3/4 in. (19 mm) or 1 in. (25 mm) ID
<b>Pump Air Supply</b>	3/8 in. (9.5 mm) ID
<b>Air Exhaust</b>	1/2 in. (13 mm) ID

<sup>1</sup> Applies to QED supplied tubing; other tubing sources may not conform to QED fittings.

Low-Drawdown AP4+ AutoPumps are warranted for one (1) year.

## Application Limits (Base model)

AP4+ AutoPumps are designed to handle the application ranges described below. For applications outside these ranges, consult QED about AP4+ upgrades.

**Maximum Temperature:** 180°F (82°C)

**pH Range:** 4-9

**Solvents and Fuels:** diesel, gasoline, JP1-JP6, #2 heating oils, BTEX, MTBE, landfill liquids

\*Consult QED for higher flow requirements

# LDAP4+T

## Flow Rates <sup>1</sup>

3/4 inch (19 mm)  
Inside Diameter Discharge Hose  
(Equivalent to 1-Inch O.D. Tubing)

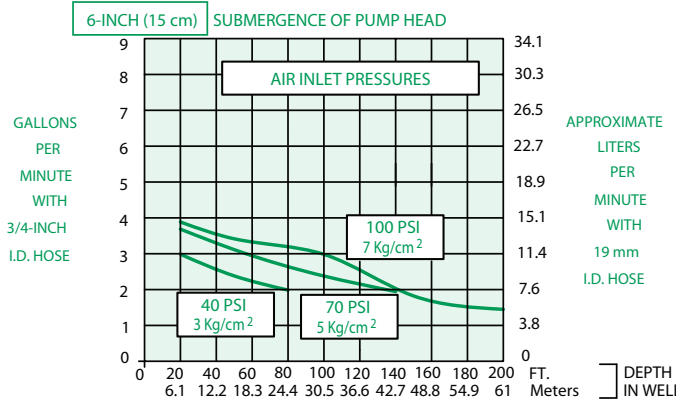

1 inch (25.4 mm)  
Inside Diameter Discharge Hose  
(Equivalent to 1.25-Inch O.D. Tubing)

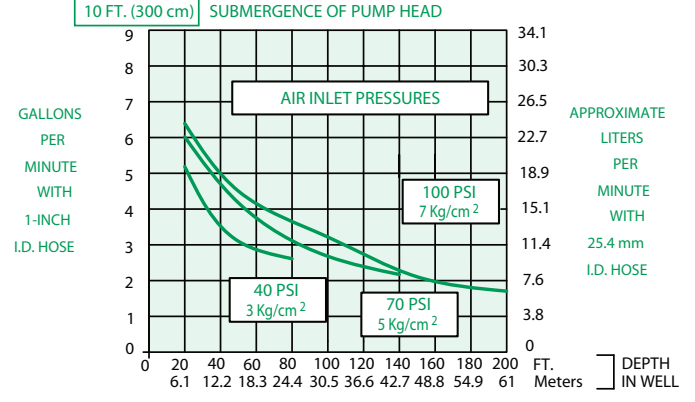
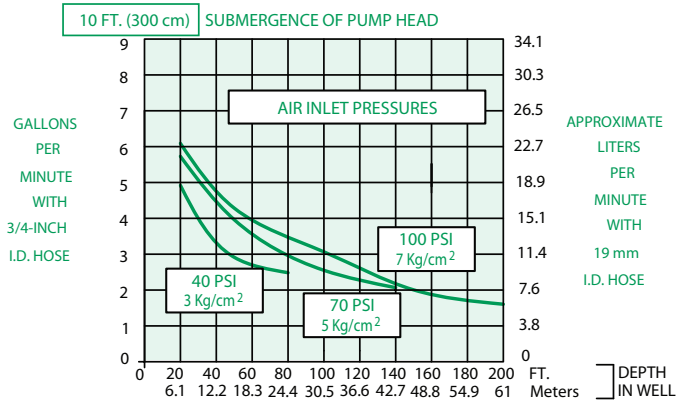
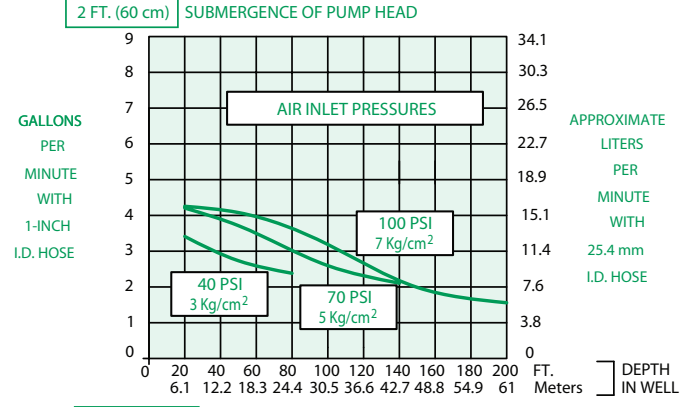
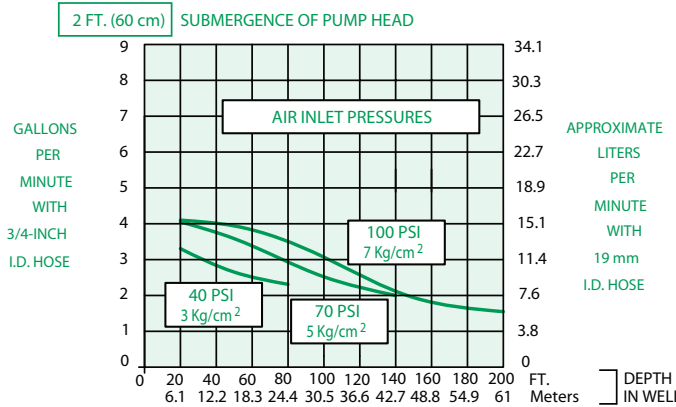
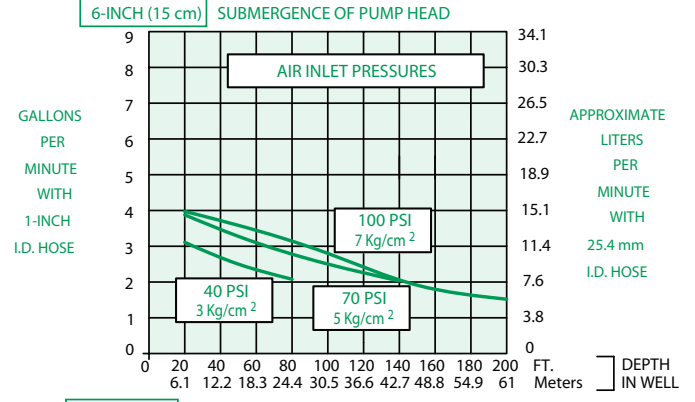

<sup>1</sup>FLOW RATES MAY VARY WITH SITE CONDITIONS. CALL QED FOR TECHNICAL ASSISTANCE.

# LDAP4+T



STANDARD  
CUBIC FEET OF AIR  
PER  
GALLON PUMPED  
(SCF/GAL)

## Air Consumption

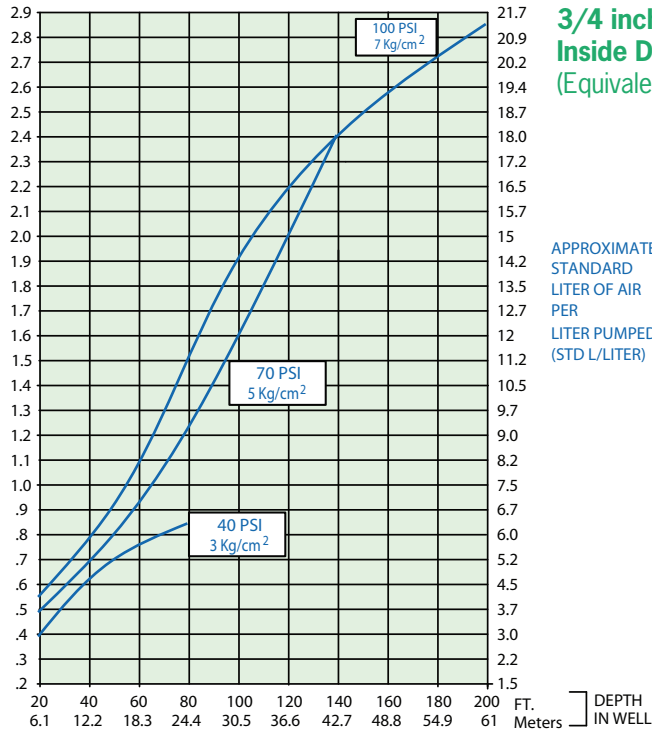

**3/4 inch (19 mm)**  
**Inside Diameter Discharge Hose**  
(Equivalent to 1-Inch O.D. Tubing)

APPROXIMATE  
STANDARD  
LITER OF AIR  
PER  
LITER PUMPED  
(STD L/LITER)

STANDARD  
CUBIC FEET OF AIR  
PER  
GALLON PUMPED  
(SCF/GAL)

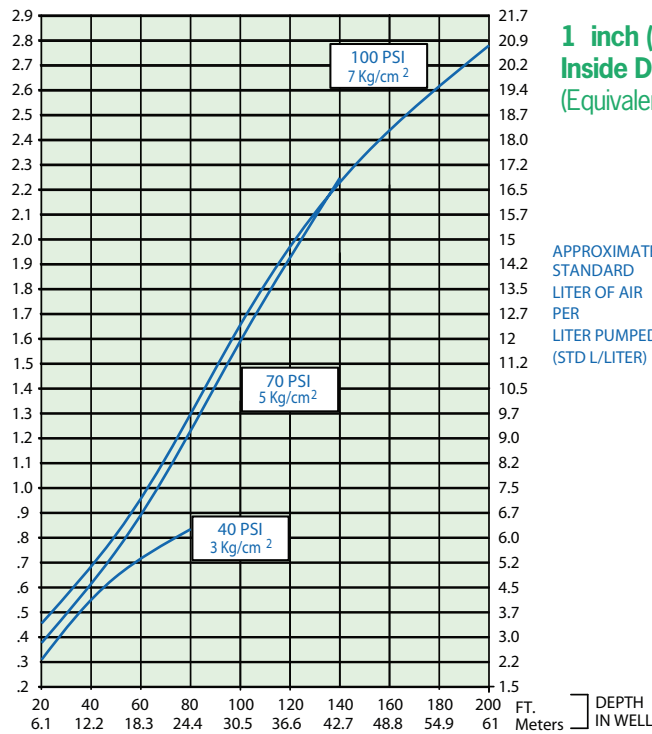

**1 inch (25.4 mm)**  
**Inside Diameter Discharge Hose**  
(Equivalent to 1.25-Inch O.D. Tubing)

APPROXIMATE  
STANDARD  
LITER OF AIR  
PER  
LITER PUMPED  
(STD L/LITER)

## Five Year Warranty

This limited warranty is in lieu of and excludes all other representations made by advertisements, distributors, agents, or manufacturers sales representatives, and all other warranties, both express and implied. There are no implied warranties of merchantability or of fitness for a particular purpose for goods covered hereunder.

QED Environmental Systems warrants to the purchaser of its products that, subject to the limitations and conditions provided within the Terms & Conditions of Sale, products, materials and/or workmanship shall reasonably conform to descriptions of the products and shall be free of defects in material and workmanship.

All warranty durations are calculated from the original date of purchase—determined as beginning the date of shipment from QED facilities and the date QED is notified of a warranty claim. This warranty shall be limited to the duration and conditions set forth below.

**1. AP4+ AutoPumps** – Warranted for five (5) years: 100% material and 100% workmanship. This limited warranty coverage only applies to long and short AP4+ AutoPumps purchased with this warranty. There will be no warranty for application or material compatibility. The materials used in pumps vary depending upon application and the customer is responsible for knowing the environment in which the pump will be operating and working with QED to determine what materials of construction will be best for the application. Note: The foregoing does not apply to AP4+ Leachate AutoPumps when used in landfill leachate applications.

The warranty is valid when the following conditions exist: when the site has a pH between 4 and 9, has a salinity of 3500 ppm or less, is between 40 and 180 degrees Fahrenheit, is non-corrosive to the construction materials of the pump; and is not abrasive. Typical commercial fuels are acceptable materials in free or dissolved phase. The pumps and accessories must be operated within the specifications and limits given in the manual for the particular piece of equipment. Note: The foregoing does not apply to AP4+ Leachate AutoPumps when used in landfill leachate applications.

**2. AP4+ “Leachate” AutoPumps** – Warranted for five (5) years: 100% material and 100% workmanship. This limited warranty coverage only applies to long and short AP4+ “Leachate” AutoPumps (301881P, 301882P). Any 304 stainless steel pump component that fails due to chemical attack during this warranty period will be upgraded to 316 stainless steel by QED, free of charge. The warranty is valid when the pumps are used in landfill leachate applications, between 40 and 180 degrees Fahrenheit, that are not abrasive.

**3. Hose, Tubing, Fittings, And Air Filtration Housings** - Warranted for one (1) year: 100% material and 100% workmanship. There will be no warranty for application or material compatibility. The materials used vary depending upon application and the customer is responsible for knowing the environment in which the equipment will be operating and working with QED to determine what materials of construction will be best for the application.

**4. Wellheads, Well Caps, Flow Meters, Pneumatic Data Modules** - Warranted for one (1) year: 100% material and 100% workmanship.

**5. Precision Fine Tune Control Valves** - Warranted for two (2) years: 100% material and 100% workmanship.

**6. Parts and Repairs** - Warranted for ninety (90) days: 100% material and 100% workmanship; when repairs are performed by QED or its appointed agent; from date of repair or for the full term of the original warranty, whichever is longer. Separately sold parts are warranted for ninety (90) days: 100% materials and 100% workmanship.

This warranty will be void in the event of unauthorized disassembly of component assemblies. Defects in any equipment that result from abuse, operation in any manner outside the recommended procedures, use and applications other than for intended use or exposure physical environments beyond the designated limits of materials and construction, will also void the warranty.

Chemical attack by liquids, gases or abrasive substances contacting equipment and accessories shall not be covered by this warranty. A range of materials of construction is available from QED and it is the buyer's responsibility to select materials of construction to fit buyer's application. QED will only warrant that the supplied materials will conform to published QED specifications and generally accepted standards for that particular material. Note: This warranty does cover chemical attack to 304 stainless steel components (see part 2 above) of AP4+ “Leachate” AutoPumps (301881P, 301882P) when the pumps are used in landfill leachate applications, between 40 and 180 degrees Fahrenheit, that are not abrasive.

QED Environmental Systems shall be released from all obligations under all warranties if any product covered hereby is repaired or modified by persons other than QED service personnel (unless such repair by others is made with the written consent of QED); resold to other parties; and/or moved to or used on a site other than originally specified.

It is understood and agreed that QED Environmental Systems shall in no event be liable for incidental or consequential damages resulting from its breach of any of the terms of this agreement, nor for special damages, nor for improper selection of any product described or referred to for a particular application. Liability under this warranty is limited to repair or replacement F.O.B. QED's factory, or its appointed agent's shop, of any parts which prove to be defective within the duration and conditions set forth herein, or repayment of the purchase price at the option of QED, provided the products have been returned in accordance with the duration and conditions set forth herein.

#### **Subassemblies and Other Equipment Manufactured by Others**

The foregoing warranty does not apply to major subassemblies and other equipment, accessories, and other parts manufactured by others, and such other parts, accessories, and equipment are subject only to the warranties, if any, supplied by their respective manufacturers. QED makes no warranty concerning products or accessories not manufactured by QED. In the event of failure of any such product or accessory, QED will give reasonable assistance to Buyer in obtaining from the respective manufacturer whatever adjustment is reasonable in light of the manufacturer's own warranty.

#### **Illustrations and Drawings**

Reasonable effort has been made to have all illustrations and drawings accurately represent the product(s) as it actually was at the time of doing the illustrations and drawings. However, products may change to meet user requirement and therefore may not be reflected in the literature. In addition, literature may be updated to reflect the most recent equipment revision(s). Changes to either or both equipment and/or literature can be made without notice.

#### **Buyer's Remedies**

The buyer's exclusive and sole remedy on account of or in respect to the furnishing of defective material or workmanship shall be to secure replacement thereof as aforesaid. QED shall not in any event be liable for the cost of any labor expended on any such product or material or for any special, direct, indirect or consequential damages to any one by reason of the fact that it shall have been deemed defective or a breach of said warranty.

#### **Changes without Notice**

Prices and specifications are subject to change without notice.

#### **Shipping Dates**

Shipping dates are approximate and are subject to delays beyond our control.

#### **F.O.B. Point and Title**

All material is sold F.O.B. factory. Title to all merchandise sold shall pass to Buyer upon delivery by Seller to carrier at factory. All freight insurance is the responsibility of the Buyer and shall be charged to the Buyer on the invoice unless directed in writing. All Freight claims are the Buyer's responsibility.

#### **Terms**

Payment terms are Net 30 days; 1.0% per month past due.

#### **State and Local Taxes**

Any taxes, duties or fees which the seller may be required to pay or collect upon or with respect to the sale, purchase, delivery, use or consumption of any of the material covered hereby shall be for the account of the Buyer and shall be added to the purchase price.

#### **Acceptance**

All orders shall be subject to the terms and conditions contained or referred to in the Seller's quotation, acknowledgments, and to those listed here and to no others whatsoever. No waiver, alteration or modification of these terms and conditions

shall be binding unless in writing and signed by an executive officer of the Seller. All orders subject to written acceptance by QED Environmental Systems, Ann Arbor, MI, U.S.A.

**Warranty Claims Procedure (Responsibility of purchaser)**

The original purchaser's sole responsibility in the instance of a warranty claim shall be to notify QED or its appointed agent, of the defect, malfunction, or other manner in which the terms of this warranty are believed to be violated. The purchaser may secure performance of obligations hereunder by contacting the Customer Service Department of QED or its appointed agent, and:

1. Identifying the product involved by model or serial number, or other sufficient description, that will allow QED, or its appointed agent, to determine which product is defective.
2. Specifying where, when, and from whom the product was purchased.
3. Describing the nature of the defect or malfunction covered by this warranty.
4. After obtaining authorization from QED, sending the malfunctioning component via a RMA# (Return Material Authorization number) to the address below or to its appointed agent:

**QED Environmental Systems  
1670 Alvarado Street, Suite 5  
San Leandro, California  
94577-2640 USA**

**(800) 537-1767 Toll-Free in North America  
(510) 346-0400 Tele.  
(510) 346-0414 FAX**

If any product covered hereby is actually defective within the terms of this warranty, purchaser must contact QED, or its appointed agent, for determination of warranty coverage. If the return of a component is determined to be necessary, QED, or its appointed agent, will authorize the return of the component at Purchasers expense. If the product proves not to be defective within the terms of this warranty, then all costs and expenses in connection with the processing of the Purchaser's claim and all costs for repair, parts, labor, and shipping and handling, as authorized by owner hereunder, shall be borne by the Purchaser. In no event shall such allegedly defective products be returned to QED, or its appointed agent, without its consent, and QED's, or its appointed agent's, obligations of repair, replacement or refund are conditional upon the buyer's return of the defective product to QED, or its appointed agent. All equipment returned to QED will be appropriately cleaned of contamination before shipping.

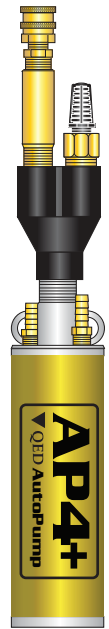

2355 Bishop Circle West  
Dexter, Michigan 48130  
1-800-624-2026 (North America Only)  
(734) 995-2547 - Tele  
(734) 995-1170 - Fax  
info@qedenv.com - E-mail  
www.qedenv.com

1670 Alvarado Street, Suite 5  
San Leandro, California 94577-2640  
1-800-537-1767 (North America Only)  
(510) 346-0400 - Tele  
(510) 346-0414 - Fax



## AP4+ Operations Manual

*Leaders in Environmental Compliance Products*